

Manual Retractable Fittings

Pharm

Food



SensoGate® WA 131 MH

Innovative manual retractable fitting with easy-to-operate rotary drive for hygienic applications

For applications in which pneumatic fittings are not essential, Knick has now developed the SensoGate® WA 131 MH, a modern manual sensor lock-gate fully compatible with its automatic "sister fittings". This applies to rinsing chambers and process connections as well as the materials used.

Revolutionary operation

The SensoGate® WA 131 MH has a manual rotary drive, which enables the fitting to be operated up to a counter pressure of 10 bar – and this in less than two turns. Regardless of how unfavorable the angle or the operating height at which the fitting is installed, the low rotary forces can easily be applied using the wrist. This is not possible with the sliding motion of conventional fittings.

Facts

- steam-sterilizability validated for all process-wetted parts incl. rinsing/calibration chamber
- directed flow rinses the process seal from the process side as well as from the inside of the fitting
- perfect sensor cleaning effect by cyclone rinsing
- safe separation to the process during probe movement and prevention of re-contamination
- double gaskets with leakage bores prevent microbial contamination of the drive
- broad applications in hygienic conditions
- cost reduction by simple installation, operation, and maintenance
- very high availability
- protective rinsing of the seals for a long service life
- SensoLock for high safety of operation
- integrated limit switches
- fast and uncomplicated replacement of calibration chamber and immersion tube
- all maintenance can be performed on site
- superior sensor immersion depth
- standard sensor length (225 mm) even for large immersion depths
- multiple process connections available
- process-wetted parts: stainless steel 1.4404, electropolished
- modular design
- special version for sensors with pressurizable liquid electrolyte
- SIP and CIP capable in the process
- SIP and CIP of calibration chamber and media routing

Specifications

Permissible process pressure and temperature during movement	10 bar (at 0 ... 140 °C)
Permissible process pressure and temperature, statically in service position	16 bar (at 0 ... 40 °C)
Ambient temperature	-10 ... +70 °C
Ingress protection	IP 66
Housing material	stainless steel A2
Permissible pressure for probe control	4 ... 7 bar
Sensors	
With gel electrolyte	Ø 12 mm, length 225 mm with temp detector, Pg 13.5 thread
With liquid electrolyte	Ø 12 mm, length 250 mm with temp detector
Process adaptations	
Dairy pipe, DIN 11851	DN 50 to 100
Ingold socket, 25 mm	25 mm
Clamp 1.4404	clamp 1" to 3.5"
Varivent 1.4404	for pipes from DN 50, from DN 65 short, from DN 80 long
BioControl 1.4404	size 50/65
Connections	
Rinse and calibration media (optional)	internal thread G1/8; hose coupling G1/8; DN 4/6
Outlet (optional)	outlet hose, NW 8 EPDM 3m
For pressurized sensors	hose connection NW 6, pressure in sensor chamber 0.5 ... 1 bar above process pressure (max. 7 bar)
Immersion depths/ Installation dimensions	see dimension drawings
Process-wetted materials	see order code

Manual Retractable Fittings

Pharm

Food

SensoGate® WA 131 MH for hygienic applications

Product Line

Order No.

Hygienic Sensor Lock-Gate, Manual		WA 131 MH /	-	-	-	-	-	-	-	-	-	-	-	-	-	-	-	-
Explosion protection	for hazardous area Zone 1 without	X N																
Sensor	solid electrolyte liquid electrolyte (pressurization possible)	0 1																
Gasket material	set F – FKM FDA set E – EPDM FDA set G – FFKM FDA process-wetted set H – FFKM FDA complete	F E G H																
Process-wetted materials*	1.4404/1.4404/1.4404 (electropolished)	G																
Process adaptation	dairy pipe, DN 50 dairy pipe, DN 65 dairy pipe, DN 80	C 1 C 2 C 3																
	Ingold socket, 1.4404, 25 mm (G 1 1/4") Ingold socket, hygienic, 1.4404, 25 mm (G 1 1/4")	H 0 A H 1 A																
	Clamp 1,5", 1.4404 Clamp 2", 1.4404 Clamp 2,5", 1.4404 Clamp 3", 1.4404 Clamp 3,5", 1.4404	J 1 A J 2 J 3 J 4 J 5																
	Varivent, 1.4404 (from DN 50) Varivent, 1.4404 (from DN 50 short, from DN 80 long)	V 1 A V 2																
	BioControl, DN 50 BioControl, DN 65	L 1 A L 2 A																
Immersion depth	short long	A B																
Electrical limit signal	without with	A B																
Rinse-medium connection	G 1/8" complete with outlet hose (3 m) G 1/8" complete with outlet hose (3 m), inlet G 1/8" G 1/8" complete with outlet hose (3 m), inlet G 1/8" and inlet hose (5 m) complete with coupling nut	0 1 2																
Housing material	stainless steel / PP (< 6 bar operating pressure) stainless steel / PEEK (< 10 bar operating pressure)	1 2																
Special variant	without equipped with special grease (provided by customer)																0 0 0 0 0 1	

* Material combinations: Process-wetted part of calibration chamber/rinse-wetted part of calibration chamber/immersion tube

Accessories		Order No.
Service set	basic equipment	ZU 0680
	maintenance, repair, retrofit	ZU 0740
	calibration chamber	ZU 0754
Sensor mounting wrench, 19 mm		ZU 0647
Mounting aid	for 20 x 2.5 O-rings	ZU 0747
	for scraper ring	ZU 0746
Bellows (version for liquid electrolyte sensors)		ZU 0739
Protective cap (version for sensors with polymeric electrolyte)		ZU 0759
Material Certificate 3.1		ZU 0708
Air supply	for pressurized sensors, 0.5 ... 4 bar	ZU 0670/1
	for pressurized sensors, 1 ... 7 bar	ZU 0670/2
Hose, 20 m (extension for ZU 0670)		ZU 0713
Safety weld-in socket, straight, 40 mm	for tank wall	ZU 0717
	for pipe, DN 50	ZU 0717/DN50
	for pipe, DN 65	ZU 0717/DN65
	for pipe, DN 80	ZU 0717/DN80
	for pipe, DN 100	ZU 0717/DN100
Safety weld-in socket, beveled, 15°, 40 mm	for tank wall	ZU 0718
	for pipe, DN 50	ZU 0718/DN50
	for pipe, DN 65	ZU 0718/DN65
	for pipe, DN 80	ZU 0718/DN80
	for pipe, DN 100	ZU 0718/DN100
Retainer clamp for 25 mm socket		ZU 0818

Manual Retractable Fittings

Pharm

Food

SensoGate® WA 131 MH for hygienic applications

Gaskets		Set	Contact (process/rinse medium)	Order No.
Dairy pipe, Varivent, clamp	E/1	EPDM FDA	ZU 0700/1	
	E/2	EPDM FDA/EPDM FDA	ZU 0841	
	F/1	FKM FDA	ZU 0697/1	
	F/2	FKM FDA/FKM FDA	ZU 0842	
	G/1	FFKM FDA	ZU 0766/1	
	G/2	FFKM FDA/EPDM FDA	ZU 0843	
	H/2	FFKM FDA/FFKM FDA	ZU 0844	
	Ingold socket H0	E/1	EPDM FDA	ZU 0704/1
		E/2	EPDM FDA/EPDM FDA	ZU 0845
F/1		FKM FDA	ZU 0703/1	
F/2		FKM FDA/FKM FDA	ZU 0846	
G/1		FFKM FDA	ZU 0768/1	
G/2		FFKM FDA/EPDM FDA	ZU 0847	
H/2		FFKM FDA/FFKM FDA	ZU 0848	
Ingold socket H1		E/1	EPDM FDA	ZU 0704/1
		E/2	EPDM FDA/EPDM FDA	ZU 0849
	F/1	FKM FDA	ZU 0703/1	
	F/2	FKM FDA/FKM FDA	ZU 0850	
	G/1	FFKM FDA	ZU 0768/1	
	G/2	FFKM FDA/EPDM FDA	ZU 0851	
	H/2	FFKM FDA/FFKM FDA	ZU 0848	
	Spare Parts			Order No.
	Immersion tube	1.4404	ZU 0764	

Dimension Drawings

Installation dimensions for SensoGate® WA 131 MH for sensors with liquid electrolyte

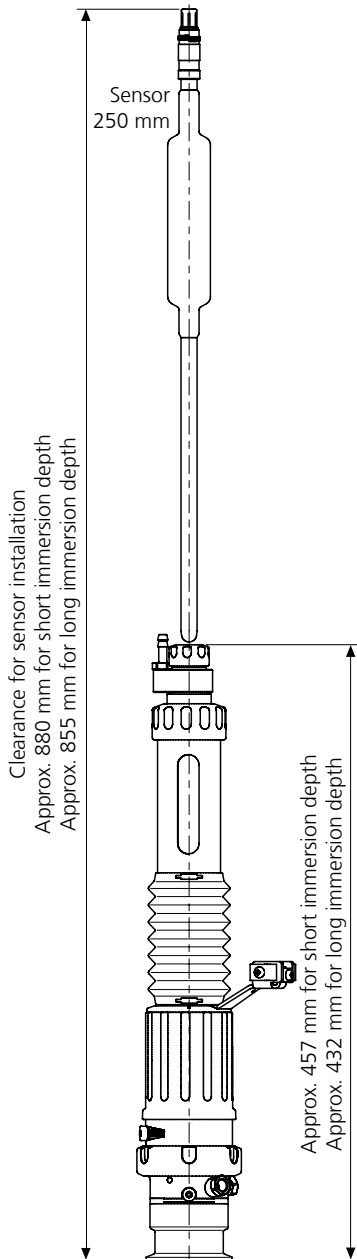

Installation dimensions for SensoGate® WA 131 MH for sensors with gel electrolyte

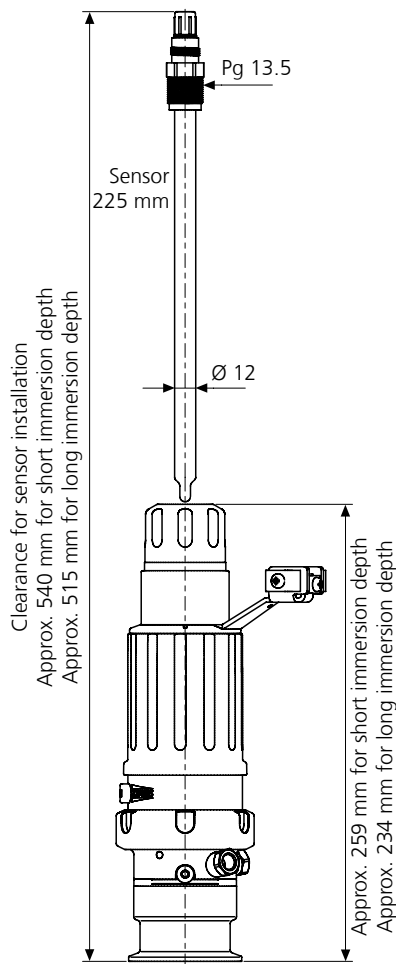

SensoGate® WA 131 MH Process adaptation for Varivent DN 50, short immersion depth

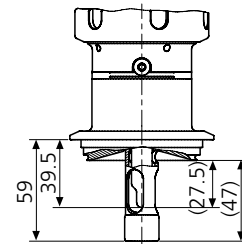

SensoGate® WA 131 MH Process adaptation for Varivent from DN 80, long immersion depth

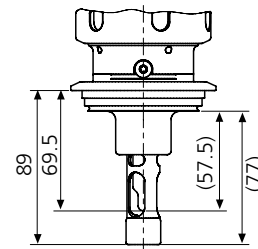

SensoGate® WA 131 MH Process adaptation for Varivent from DN 65, short immersion depth

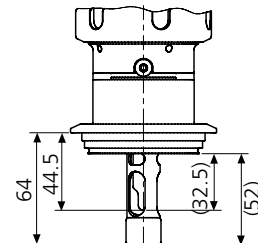

All dimensions in mm

Manual Retractable Fittings

Pharm

Food

SensoGate® WA 131 MH for hygienic applications

Dimension Drawings – continued

SensoGate® WA 131 MH
Process adaptation for
Triclamp 2; ... 3.5;;
long immersion depth

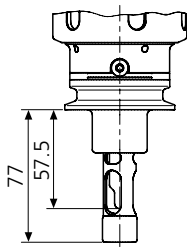

SensoGate® WA 131 MH
Process adaptation for dairy pipe
DN 11851 DN 50 ... DN 100,
long immersion depth

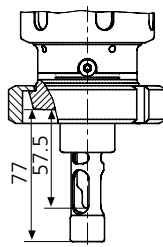

SensoGate® WA 131 MH
Process adaptation for
Ingold socket, 25 mm

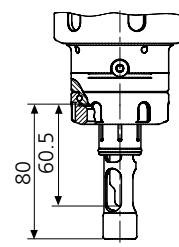

SensoGate® WA 131 MH
Process adaptation for
Triclamp 1; ... 3.5;;
short immersion depth

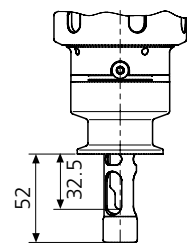

SensoGate® WA 131 MH
Process adaptation for dairy pipe
DN 11851 DN 50 ... DN 100,
short immersion depth

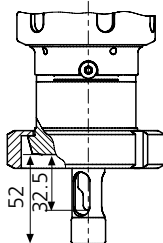

SensoGate® WA 131 MH
Process adaptation for
BioControl DN 50/DN 65

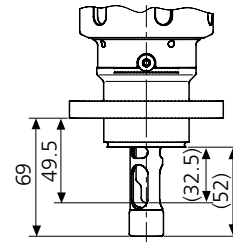

For up-to-date information, please visit www.knick-international.com

Knick 

DP-FLOW

www: www.dp-flow.co.uk email: sales@dp-flow.co.uk