

Uf 841

(full pipe)

User manual

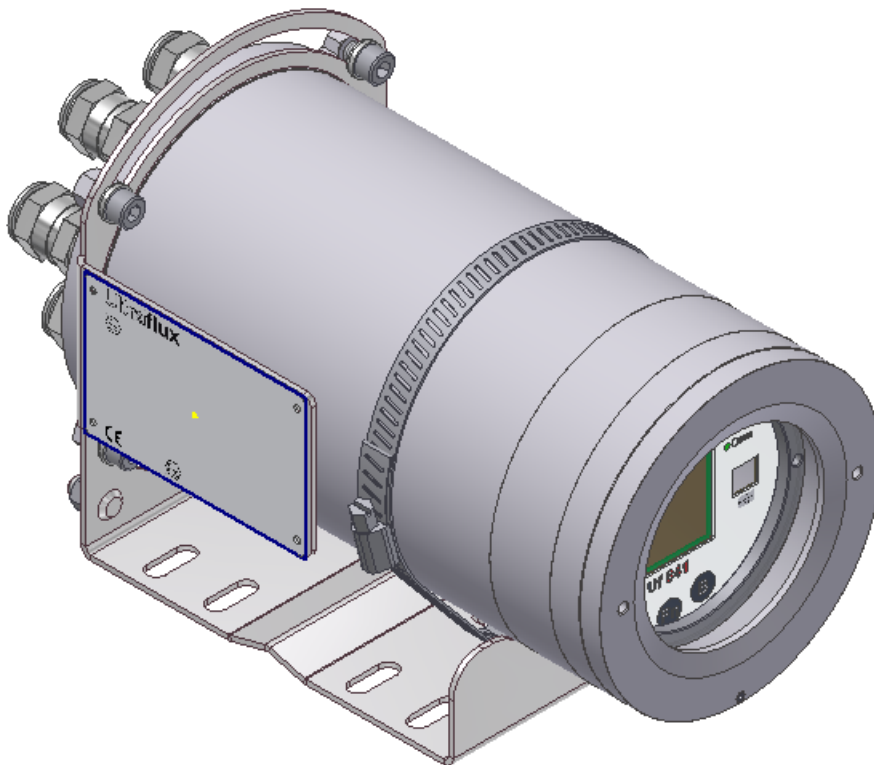

Ultraflux

Bâtiment Texas – Éragny Parc
9, Allée Rosa Luxemburg
95610 ÉRAGNY SUR OISE, FRANCE
Tel.: 33 (0)1 30 27 27 30
Fax: 33 (0)1 30 39 84 34

2014 ULTRAFLUX S.A.

All rights reserved. No part of this document may be reproduced without prior written authorisation from ULTRAFLUX S.A. ULTRAFLUX, Uf 841 are registered trademarks of ULTRAFLUX S.A.

TABLE OF CONTENTS

Note: A detailed table of contents is provided at the end of the manual.

Important: If you are unfamiliar with the transit time difference measuring technique, we recommend you start by reading our training manual, "Ultrasonic transit time flowmeter".

CHAPTER 1: OVERVIEW	4
1.1 Overall view of the converter	5
1.2 Functions	7
1.3 Dimensions and weight	7
1.4 Operating environment	7
1.5 Protection against dust and immersion	7
1.6 Power supply	8
1.7 Communication	8
1.8 Inputs/Outputs	9
1.9 Ultrasound chords	9
1.10 Navigation keys	9
1.11 Operating lights	10
1.12 Screen	10
1.13 Performance of the flow meter	11
1.14 Cleaning the flow meter	11
1.15 Recycling the flow meter	11
1.16 CE marking	11
CHAPTER 2: SAFETY INSTRUCTIONS	12
2.1 Using the flow meter	13
2.2 Equipment connected to the flow meter	13
2.3 Symbols used on the flow meter	14
2.4 Maintenance work on the flow meter	15
2.5 Contact address	16
CHAPTER 3: INSTALLATION AND WIRING	17
3.1 General	18
3.2 Attachment	18
3.3 Opening the casing	20
3.4 Wiring instructions	20
3.5 Connection to the protective ground (to be carried out first)	21
3.6 Wiring the Terminals	21

CHAPTER 4: INSTALLING A MEASURING POINT	25
4.1 Composition of a measuring point	26
4.2 Choosing the measurement location	26
4.3 Choosing the probe location	30
4.4 Installing probes and connectors	32
CHAPTER 5: USING AND CONFIGURING THE Uf 841	35
5.1 Using the Uf 841	36
5.2 Main configuration elements	39
5.3 Configuring the Uf 841	39
5.4 SIMPLE configuration	41
5.5 NORMAL configuration	53
5.6 ADVANCED configuration	57
5.7 "Measurement" mode	61
CHAPTER 6: FUNCTION ENGINE	64
6.1 Principle	65
6.2 Application examples: Calorimetry	65
6.3 Application examples: Conversion of gas flow rate into standardised flow rate	67
CHAPTER 7: PC SOFTWARE	68
7.1 Introduction	69
7.2 Archiving, processing and printing of saved files	81
7.3 Settings files	81
Appendix I: Characteristic echo signals	82
Appendix II: Speed of sound in water	85
Appendix III Troubleshooting	87
III.1 Diagnostic indications	88
III.2 Description of fault bits	90
III.3 Fault grid	93
Appendix IV: Link protocol of the Uf 841	94
IV.1 Serial link characteristics	95
IV.2 Reading of N words (with $N \leq 125$)	96
IV.3 Modbus / Jbus table	97
IV.4 CRC16 calculation algorithm	101

CHAPTER 1: OVERVIEW

1.1 Overall view of the converter

1.1.1 Unit closed

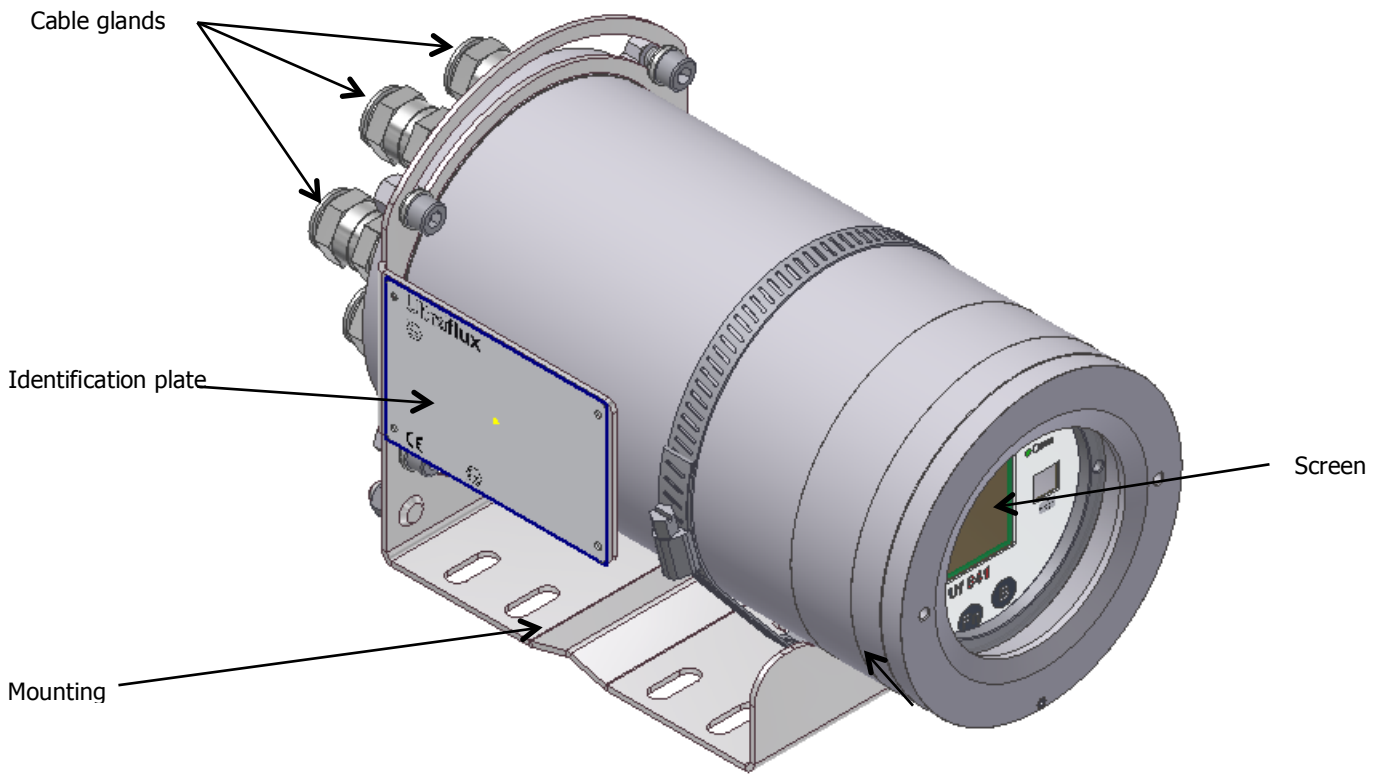

General view

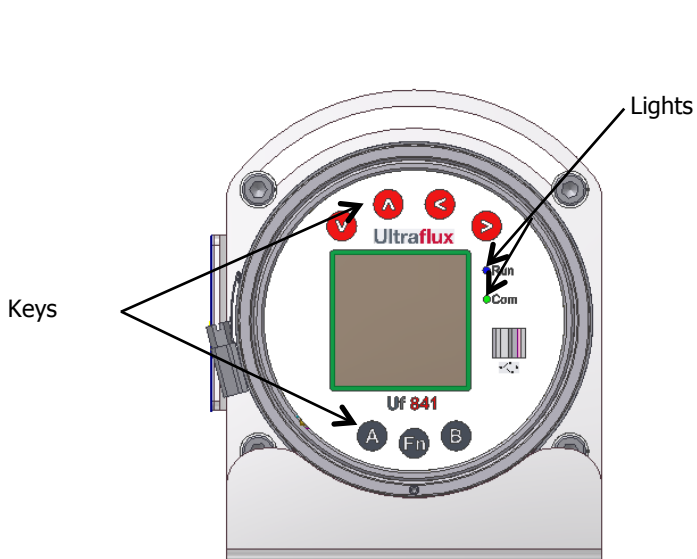

Front view without cover

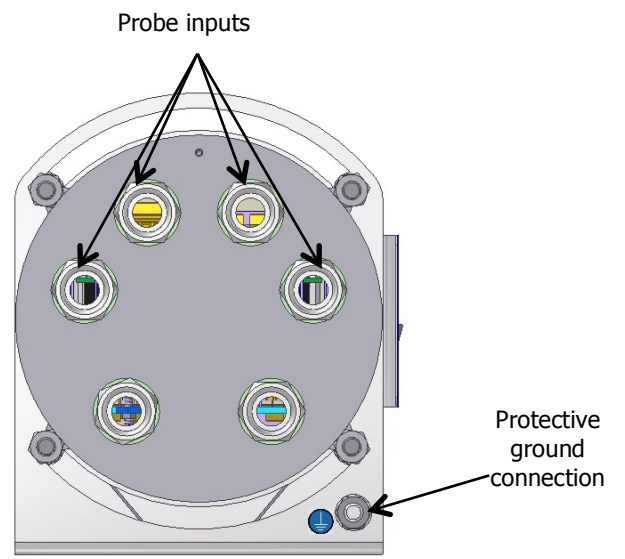

Rear view

1.1.2 Unit open

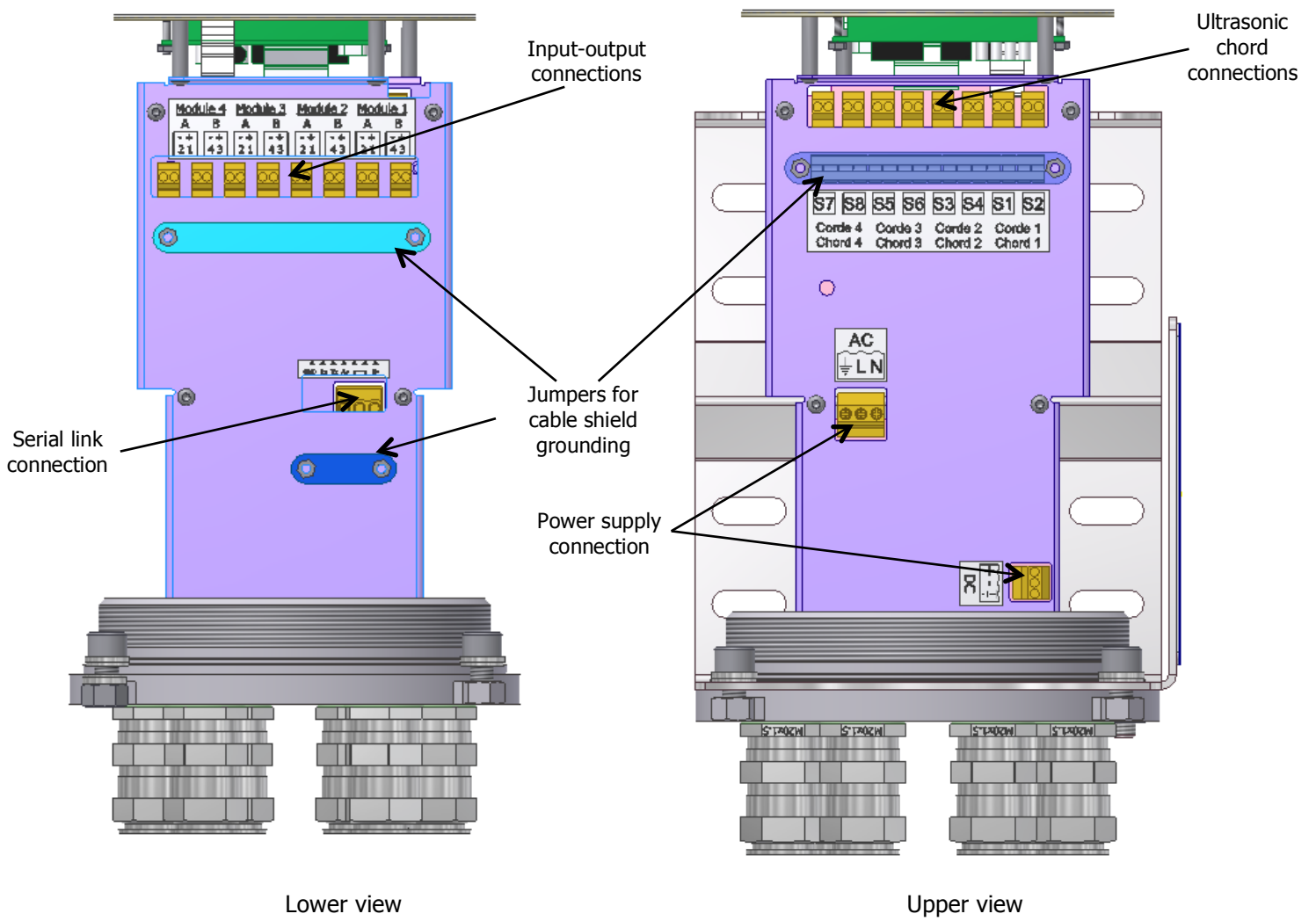

Lower view

Upper view

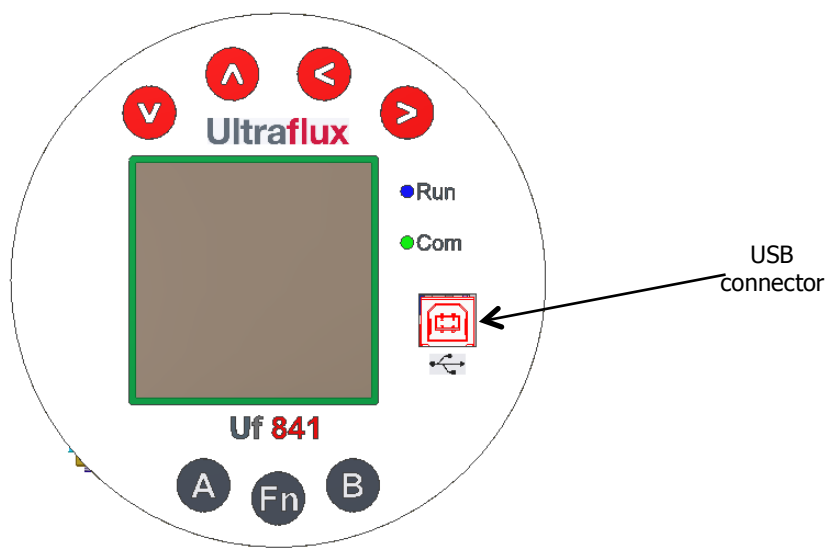

Displayer view

1.2 Functions

The UF 841 is an ultrasonic flow meter used to measure flows using the transit time difference method.

The measurement can be taken using an installation with up to 4 ultrasonic measurement chords. (One chord designates the acoustic path between two probes, each alternating between emitting and receiving. The use of several chords is above all required when the hydraulic conditions are poor and high accuracy is required).

1.3 Dimensions and weight

- Height: 160 mm
- Width: 142 mm
- Depth: 273 mm (including glands)
- Weight: 12 kg

1.4 Operating environment

- For internal or external use
- Temperature: -20°C to +50°C
- Ventilation: no specific precautions
- Maximum altitude: 2,000 metres
- Danger zone: ATEX zone 1 / 2 / 21 / 22 - Class 1 / Class 2 division 1 or 2
- Hygrometry: 80 % maximum

1.5 Protection against dust and immersion

IP 67: Total protection against dust; protection against immersion for 30 minutes under 1m of water. This protection is only valid if the installation has been carried out or audited by Ultraflux.

This seal is only effective when the glands and/or plugs are in place and tightened (tightening torque checked).

1.6 Power supply

- Range: from 10 to 32 VDC, or from 110 to 240 VAC 50-60Hz
- Peak power consumption: < 15 W
- Protection through resettable fuse
- Overvoltage protection in accordance with standard EN 61000-4-5
- Typical average consumption: < 6 W
- Protection against polarity reversal
- Transient overvoltage: overvoltage category II

Important safety-related notes:

- A bipolar isolating switch with visible 2 A cut-off upstream of the device's power supply must be installed. It is also recommended to install lightning arrestors on each of the unit's inputs/outputs (requires specialist advice).
- Whatever the means of power supply to the unit, it is recommended to install an isolating mechanism close to it (emergency stop or other).
- The flow meter is designed for fixed installation and must not be connected to the mains with a plug-in cable (risk of an unidentified or poorly identified phase on a mains socket). It must be connected to a terminal board on which the phase is correctly identified.
- Crimp wiring lugs must be fitted on the exposed ends of the cable used to connect the mains to the terminal board provided for this purpose (Ground + phase + neutral).
- The terminal boards must only be connected or disconnected with the power off and the equipment isolated.
- During maintenance or installation operations, the protective ground (external ground connection on the box) must be connected first and disconnected last.

Ultraflux accepts no responsibility for incidents which may occur following a failure to respect these instructions.

1.7 Communication

The Uf 841 has a serial link which can be wired using **RS232** or **RS485** mode, as well as a **USB port**. For this communication interface, the standard protocol chosen is the Slave JBUS (MODBUS). This enables the unit to be connected to an instrumentation and control system or to a computer. Ultraflux provides PC software compatible with Windows (XP or later) which is used to configure the machine, unload the logger data and display the various values measured.

Please refer to the appendices for the JBUS/MODBUS configuration.

Note:

- The 120 Ohm "termination" resistance is provided in the electronic card to connect the RS485 A/+ and B/- signals. To connect it, a jumper (strap) should be fitted to the serial link terminal board as indicated on the label describing the connection.
- A USB interface allows a computer to be connected for configuration. This may be accessed by opening the flow meter cover.

1.8 Inputs/Outputs

The Uf 841 provides the following options:

- Up to 4 input/output single modules (or 2 double modules), made by Ultraflux in the factory only (in accordance with the customer order).
- Insulation of all the inputs and outputs. There is therefore no requirement for additional insulation for the external equipment connected to them.

The Uf 841 allows 6 types of inputs/outputs to be used (maximum values in brackets):

- Single module 1 active 4-20 mA insulated analogue output: current from 0 to 24 mA (24 V maximum),
- Single module 2 passive 4-20 mA insulated analogue inputs: 0 to 24 mA (50 mA maximum),
- Single module 2 passive 0-10 V insulated analogue inputs (15 V maximum),
- Single module 2 on/off outputs that can be used as frequency outputs (50 V - 10 mA maximum),
- Single module 2 on/off inputs (5 V maximum),
- Double module 2 PT100/PT1000 temperature inputs; 2-, 3- or 4-wire.

Notes:

- Please refer to the descriptive sheet for each module for more details.
- The probes (inputs) on the 4-20 mA loop must be powered from an external power supply.

1.9 Ultrasound chords

The Uf 841 enables the control of a maximum of 4 ultrasonic chords, or 8 probes. 8 cable glands are provided to pass the probe cables through.

In principle, only ultrasonic probes supplied by Ultraflux may be used with the Uf 841. Ultraflux accepts no responsibility for damage or incidents which may occur following a failure to respect these instructions. It is however possible to use other makes of probe after consulting Ultraflux.

1.10 Navigation keys

- The "Fn" (Function) key is used to go from one menu to another. This is used in particular to enter the different "configuration" menus. The ◀ and ▶ keys are used to browse through the menus of this mode.
- Holding down the Fn key, or allowing approximately 1 minute to pass without using the keypad, returns you to "measurement" mode.
- Within any one menu, the ◀ and ▶ keys are used to change page. These keys may also have a contextual function. If this is the case, a reminder of this function will be provided at the bottom of the screen page, such as the choice of screen in measurement mode, which is displayed by default.
- After powering on the Uf 841, the screen displays the page that has been selected as priority. To choose this default screen, position yourself on it and define it by default by pressing on the "B" key.

- To scroll through the measurement screens, use the ▲ and ▼ keys.
- To access the other menus, press the "Fn" key, then successively press the ◀ key, or browse using the ◀ and ▶ keys.
- To enter a menu, press ▲ or ▼.
- To change page, press "A" or "B".
- To change a row, select it using ▲ or ▼ and change the value using ◀ or ▶.
- If no key is pressed for approximately one minute, the Uf 841 automatically returns to "measurement" mode and to the display chosen as priority using "B".
- For a given parameter, the value to be applied is defined using the ▶ (increase) and ◀ (decrease) keys. Pressing and holding one of these two keys accelerates the increase or decrease.

1.11 Operating lights

Two LEDs are present on the front panel:

- **Blue measurement LED:** indicates whether or not the flow meter is in measurement mode (as opposed to configuration mode).
 - A flashing LED indicates normal operation.
 - An LED which is fixed on or off indicates abnormal or interrupted operation.

Warning: the flow meter may be in measurement mode (inputs-outputs, function loggers) without the probes being connected.

- **Red, orange or green Communication LED:** indicates the status of the external communication of the flow meter (serial link or USB).
 - Flashing green light for each dialogue on the serial link.
 - Long red flashing light on each dialogue error on the serial link.
 - Fixed orange light when the flow calculation is in degraded mode or when a related function is faulty.
 - Fixed red light when the flow calculation is faulty.

1.12 Screen

- LCD: graphic (14 rows x 20 characters).
- Backlighting: permanent or timed.

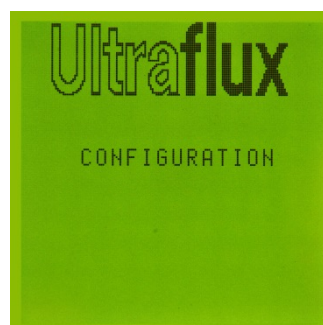

1.13 Performance of the flow meter

- Uncertainty over measured speed: up to ± 0.5 %.
- Repeatability: up to 0.1 %.
- Linearity: up to 0.1 %.
- Typical uncertainty on the flow rate calculation: from 0.5 to 5 % depending on the application and the number of chords.

Important: The accuracy of the measurement also depends on the accuracy with which the geometry of the measuring point is measured, the dimensions of the probe pairs, the distance between the probes and the length the wave has to travel between two probes. An inaccuracy on one of these values may compromise the accuracy of the measurement.

1.14 Cleaning the flow meter

The box may be cleaned with water, diluted alcohol or detergent using a sponge or a soft cloth. Do not use abrasive materials or solvents.

1.15 Recycling the flow meter

In the context of decree no. 2005-829 dated 20 July 2005 and decree no. 2009-1139 dated 22 September 2009 relating to the collection, treatment and disposal of electrical and electronic equipment, batteries and accumulators in France, Ultraflux delegates the responsibility for financial and also logistical recovery to the user, who will manage their own waste. The separate collection and recycling of your waste at the time of its disposal will help to preserve natural resources and guarantee recycling that is least harmful to the environment and human health. For further information on the closest recycling centre to your site, contact the local authority or disposal service for the waste material in question.

1.16 CE marking

The Uf 841 complies with CE certifications:

EN 55016-2-1	Measurement of conducted emissions Criterion A
EN 55016-2-3	Measurement of radiated emissions from 30 MHz – 6 GHz
EN 61000-4-6	Immunity to induced conducted disturbances Criterion B
EN 61000-4-2	Immunity to electrostatic discharges Criterion B
EN 61000-4-3	Immunity to radiated electromagnetic fields Criterion A
EN 61000-4-4	Immunity to rapid transients in bursts Criterion B
EN 61000-4-5	Immunity to shock waves Criterion B
EN 62311	Human exposure to electromagnetic fields
IEC 60529	Degree of protection provided by enclosures (IP)

CHAPTER 2: SAFETY INSTRUCTIONS

2.1 Using the flow meter

The flow meter, equipped with ultrasonic probes, is used to measure the flow of fluid (gas or liquid) in a pipe. It is important to configure the flow meter correctly for its measurement results to be correct. You are recommended to call on qualified staff from Ultraflux to ensure this is the case. This is strongly advised if your equipment is used to regulate a process, intervene in a monitoring system, or in the case of other applications for which an incorrect flow measurement could lead to risks.

In normal operation, the flow meter must not heat up to a level liable to cause burns. It is not necessary to take any particular precautions to allow it to cool. Should the temperature of the unit rise abnormally, it is recommended to power off the flow meter and call Ultraflux for expert advice. In the event of a fire inside the flow meter, power it off without opening or touching it, then call the competent services in order to secure the premises.

The flow meter must not be used beyond the possibilities and specifications given in this manual. The flow meter must be stored in a dry place, with the packaging provided by Ultraflux in order to protect the parts liable to be damaged by a shock. It is advised to wear PPE (personal protective equipment) suitable for handling and installing the apparatus.

The flow meter must only be modified or disassembled by Ultraflux personnel. Ultraflux accepts no responsibility should this rule not be respected.

The connectors must only be connected or disconnected with the power off and the equipment isolated.



For wiring and unwiring operations relating to function or maintenance, **the protective ground must be connected first and disconnected last.**



The flow meter is designed for fixed installation and must not be connected to the mains with a plug-in cable (risk of an unidentified or poorly identified phase on a mains socket). It must be connected to a terminal board on which the phase is correctly identified.

Ultraflux accepts no responsibility for incidents which may occur following a failure to respect these instructions.

2.2 Equipment connected to the flow meter

Any equipment connected to the unit must comply with its associated standard with regard to safety and have SELV circuits (double insulation between primary and secondary). All equipment connected to the flow meter must be disconnected before its protective ground is disconnected.

2.3 Symbols used on the flow meter

Symbols shown on the outside of the unit (labels or on the keyboard side):



User manual must be read before use.



The flow meter must be disconnected and the power switched off before opening the unit or connecting or disconnecting inputs and outputs.



EC marking indicates compliance with European Community requirements.



Dangerous voltages in the unit.



Hazard risk; please refer to the precautions in these user instructions.



The unit's protective ground must be connected.



Do not throw in the bin. Follow the recycling procedure indicated in these instructions.



Symbols marked on the internal panelling (labels):



Ground marking, Phase (L) and Neutral (N) on the protective cover of the mains terminal board.



Positive, negative and Ground terminals near to the low voltage power supply connection terminal board.

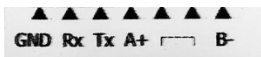

COM terminal board label: RS232 and RS485 wiring.

S7	S8	S5	S6	S3	S4	S1	S2
Corde 4	Corde 3	Corde 2	Corde 1				
Chord 4	Chord 3	Chord 2	Chord 1				

Descriptive label of terminals for connecting the probes:
S1 - S3 - S5 - S7: upstream chords; S2 - S4 - S6 - S8: downstream chords.

Module 4		Module 3		Module 2		Module 1	
A	B	A	B	A	B	A	B
-+	-+	-+	-+	-+	-+	-+	-+
21	43	21	43	21	43	21	43

Descriptive label of internal input and output module terminal connections (according to the optional modules ordered by the customer).

See paragraph 3.6 on wiring of the above terminal boards.

2.4 Maintenance work on the flow meter

Work relating to maintenance on the flow meter must only be carried out by Ultraflux staff (SAV) and using only parts supplied by Ultraflux (*).

Only operations relating to installation and start-up may be carried out without the intervention of Ultraflux:

- attachment (to wall) of the flow meter,
- connection of the equipment ground,
- connection of the probes,
- wiring of the inputs and outputs (**),
- wiring of the COM port (RS232 / RS485),
- connection of power supply,
- communication of the unit via its USB port.

(*) Except for consumables used to attach to the wall (bolting), the connection of external items connected to the unit (cables and support brackets, apart from the probe cables as these are supplied with the probes delivered by Ultraflux).

(**) The number and type of inputs and outputs available correspond to the optional modules fitted during production of the Uf 841 by Ultraflux, depending on the options ordered by the customer.

2.5 Contact address

For any requests for information, please contact us at:

ULTRAFLUX

9, Allée Rosa Luxemburg

95610 ERAGNY

FRANCE

<http://www.ultraflux.net>

E-mail : ultraflux@ultraflux.fr

Tel.: 33 (0)1 30 27 27 30

Fax: 33 (0)1 30 39 84 34

2014 ULTRAFLUX S.A.

CHAPTER 3: INSTALLATION AND WIRING

3.1 General

Before any operation on the unit, the user instructions NT300, supplied with the unit, must be read.

The Uf 841 casing presents no particular danger to the user. Depending on the environment where the unit is installed, it is however recommended to wear personal protective equipment during assembly, including: gloves, safety boots, impact goggles.

It is recommended to follow the assembly method described below in order to avoid all risk of injury.

Assembly must be carried out or inspected by Ultraflux to ensure the unit is leakproof and will operate correctly.

Important: Avoid installing the Uf 841 close to a frequency converter. If this cannot be avoided, interference filters must be installed. It is highly recommended to contact us if this situation arises.

It is also recommended to separate the paths of the measurement cables and the power cables.

3.2 Attachment

The unit's mounting plate is multi-support and may be attached to piping, to a horizontal surface or to a vertical surface as shown in the illustrations below:

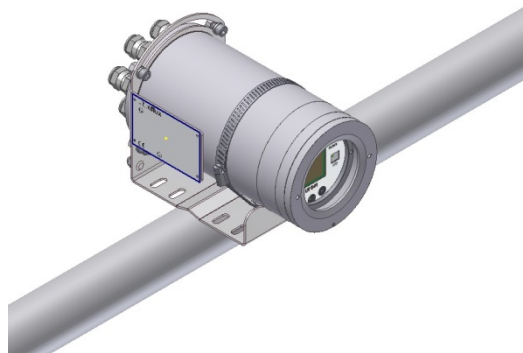

Assembly on piping

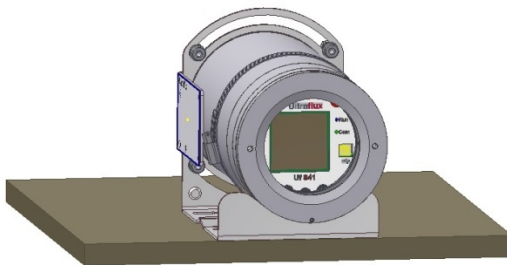

Assembly on a horizontal surface

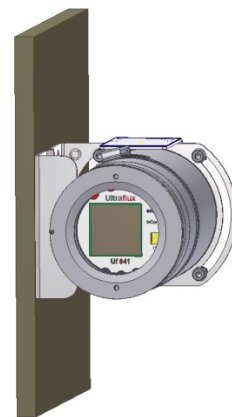

Assembly on a vertical surface

For installation on piping, you may use stainless steel straps to attach the unit, passing them through the oblong holes designed for this purpose. With regard to flat surfaces, the following holes should be made:

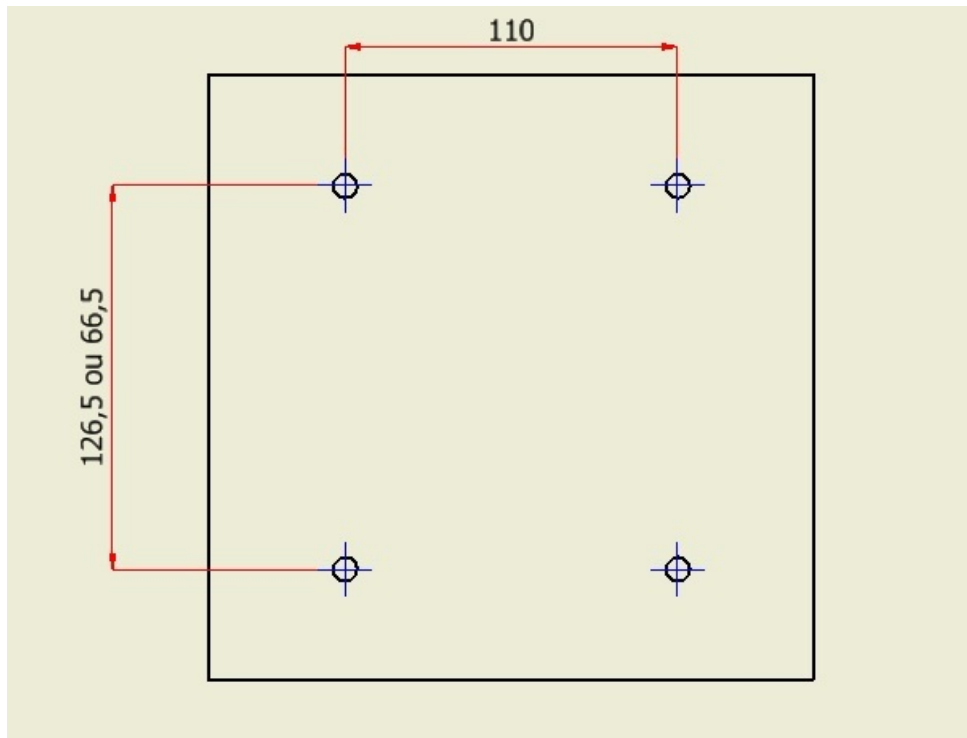

Holes should be of 9 mm diameter for bolt attachment. Support tapping is also possible. In this case, ISO M8 threaded holes must be made.

To facilitate installation of the unit, please follow the steps below:

- Attach the unit to the selected support using ISO M8 screws,
- Open the entire unit (tube + front cover) to access the board connectors,
- Connect the protective ground (see chapter 3.5),
- Pass the various cables through the cable glands,
- Connect the cables to the various terminals (see chapter 3.6),
- Tighten the cable glands (for the tightening torques, please refer to the cable gland user instructions).

3.3 Opening the casing

The casing is screwed to the rear cover. To unscrew it, firstly, remove the locking screw.

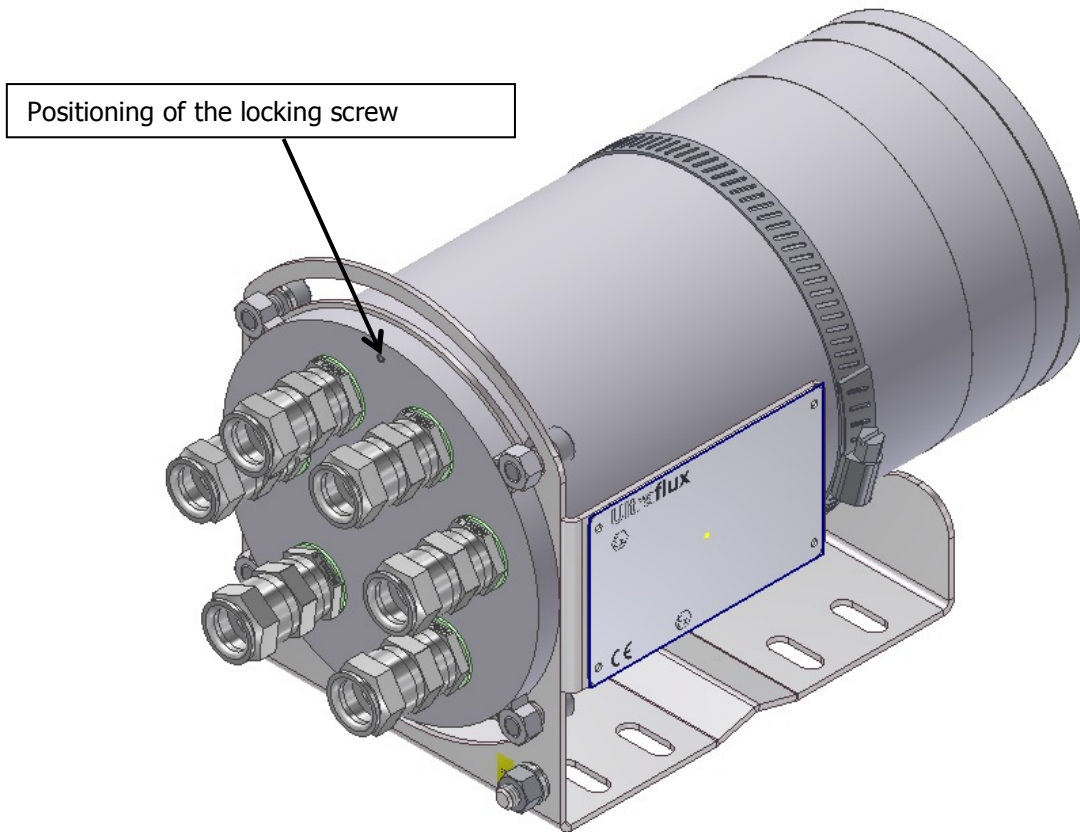

An identical locking screw may also be found on the front cover.

3.4 Wiring instructions

Wiring must be carried out by a person with electrical accreditation. The flow meter must be powered off before installing or uninstalling. The isolation devices must be locked and tagged. The wiring must comply with the diagrams provided for the power supply and for the inputs/outputs.

It is sometimes necessary to protect the inputs/outputs, the power supply and the ultrasonic chords. You are strongly recommended to contact Ultraflux to obtain a diagnosis on this point. Ultraflux accepts no responsibility in the event of the incorrect use of the flow meter, and in such cases, the Ultraflux guarantee would not be valid.

3.5 Connection to the protective ground (to be carried out first)

For the ground connection, it is recommended to use a copper braid. When choosing the braid, it is important to adhere to the following rule: Length / Width < 3. At the end of the Uf 841 ground connection contact there should be an M6 stud bolt fitted with appropriate washers and nuts. In all cases, the section of the conductor used must be greater or equal to that of the device's power supply cable conductors (see §3.6.1).

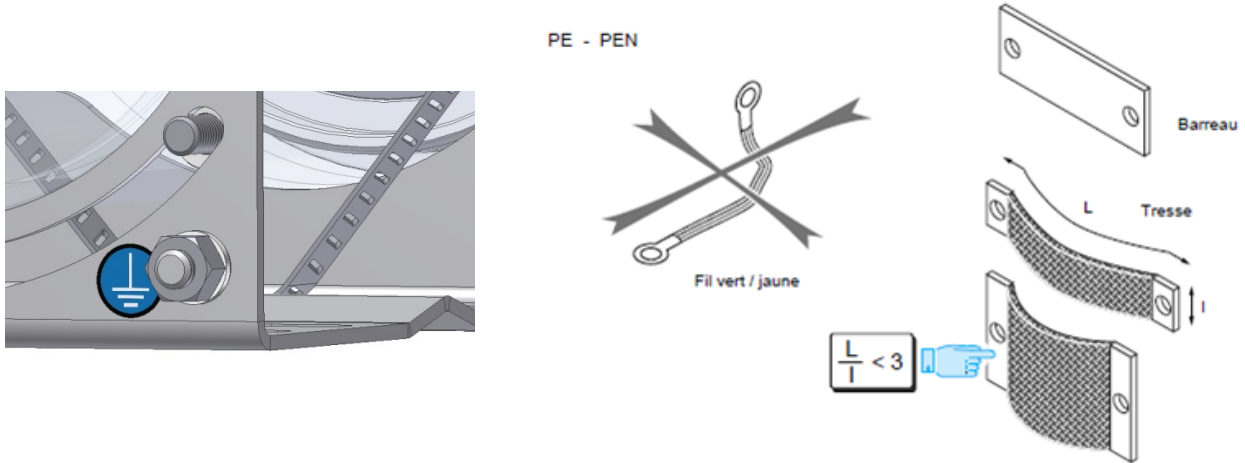

3.6 Wiring the Terminals

Apart for the USB connector, all connections require plug-in terminals that may be unplugged from the machine if this makes it easier to connect the conductors. With regard to connection of the ultrasonic probes, please refer to the example below.

3.6.1 Power supply

Mains power supply:

The mains cable must have a minimum conduction section of $3 \times 1.5 \text{ mm}^2$ and comply with the CEI 60227 or CEI 60245 standards. Its external diameter must be between 7 and 10mm inclusive so as to be well held in the cable gland provided for this cable. The green/yellow conductor must only be used for the ground connection.

3.6.2 Ultrasonic chords

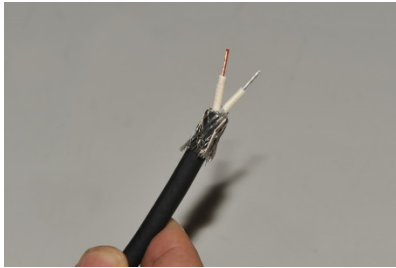

Unsheath a length of cable of between 10 and 15mm and bend back the ground braiding as shown opposite. Next, strip a length of about 5 mm of the conductors. Whilst doing this, note the colour difference of the two conductors: on the Twinax cable, the one is a galvanised colour and the other copper-coloured.

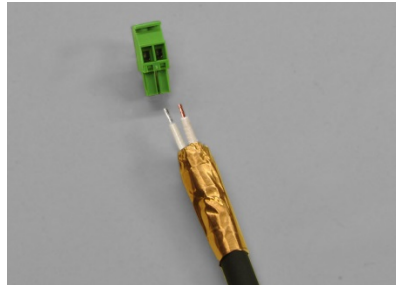

Cover the ground braiding with copper tape to prevent the threads of the ground from becoming loose and thus causing short-circuits. After passing it through the cable gland of your choice, connect the probe cable to the terminal board (disconnect the machine if this makes the operation easier), taking care always to connect the copper-coloured conductor on the same side on the terminals.

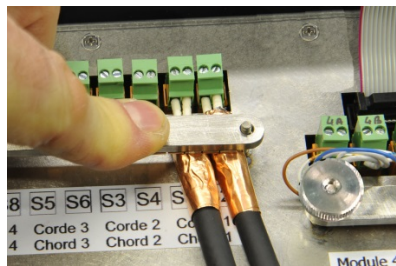

Connect the terminals to suitable positions, then place the shield connection jumper.



Only tighten the knurled nuts at the end, ensuring the shield connection jumpers are correctly secured, avoiding pressure exertion on the contact plates placed below these jumpers.

3.6.3 Input/output terminals

The RS232/485 communication and inputs/outputs must be connected to the terminals provided for this, after passing the cables through cable glands the furthest on the right. It is recommended to use at least category 5 shielded cable of folded twisted pair-type. The cable diameter should be between 6 and 12 mm.

To connect the shielding, it is recommended that the same precautions are followed as for the ultrasonic chords (copper tape). Shield connection jumpers are provided for each of the cables.

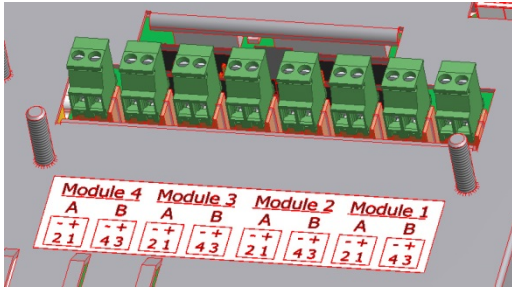

The input and output module terminals are identified by a label indicating their pin configuration. One to four modules are fitted by Ultraflux in the workshop depending on the options ordered by the customer.

After checking that these input/output modules have been actually activated through the CONFIGURATION menu, their allocation to the different connectors (1/A to 4/B) is available in the input and output configuration menu. More often than not, the modules furthest to the right (module 1, etc.) correspond to single 4/20 mA outputs and the ones next to this, to double relay modules.

Please refer to the tables below for the wiring to be carried out according to each type of module.

1) Wiring of the current output modules

Terminal pin configuration:

Pin	Function
1	Current (+)
2	Current (-)
3	---
4	---

2) Wiring of the current input modules

Terminal pin configuration:

Pin	Function
1	Current A wire 1
2	Current A wire 2
3	Current B wire 1
4	Current B wire 2

3) Wiring of the voltage input modules

Terminal pin configuration:

Pin	Function
1	Voltage A (+)
2	Voltage A (-)
3	Voltage B (+)
4	Voltage B (-)

4) Wiring of the relay modules

Terminal pin configuration:

Pin	Function
1	relay A
2	relay A
3	relay B
4	relay B

5) Wiring of the temperature modules

Note: this is a double location module

The sensors Pt 100 and Pt 1000 can be wired in different ways:

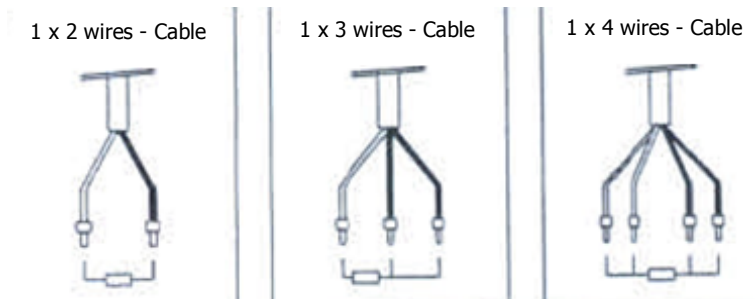

The most complete wiring is that using a 4-wire sensor:

Pin	Function
1	red wire 1
2	white wire 1
3	red wire 2
4	white wire 2

Please note: for 2- or 3-wire cables, just use "bridging" to make up for the missing wires. In the 3-wire version, a white wire is missing: simply bridge the two white wires 1 and 2 and place the white cable on the "white wire" pin.

Please note: To ensure good measurement quality, it is recommended to use shielded platinum probes. The shield connection is ensured by the ground connection jumper provided on the internal panelling.

3.6.4 Communication terminal board

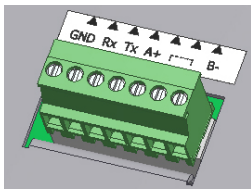

A common terminal board is provided for connecting the RS232 or RS485 communication. Only one type of communication must be used at a time. With regard to the RS485 network, this must end in a load resistor at each end of the line, especially if the cable is long. This resistance is planned for on the electronic card; simply add a jumper between points 5 and 6 to connect it.

1) RS232 mode wiring

Pin	Function
1	GND
2	Rx UF 841
3	Tx UF 841
4, 5, 6, 7	not used

2) RS485 mode wiring

Pin	Function
1, 2, 3	not used
4	A+ RS485 (=Z)
Jumper between 5 and 6	To use the load resistance
7	B - RS485 (=Y)

Type of cable to be used: same recommendations as for the inputs/outputs.

To connect the shielding, it is recommended that the same precautions are followed as for the inputs/outputs and the ultrasonic chords (copper tape). Use shield connection jumpers designed for this purpose.

CHAPTER 4: INSTALLING A MEASURING POINT

4.1 Composition of a measuring point

Apart from the electronic converter (the unit), a measuring point includes the following components:

- 1 to 4 pairs of probes
- 1 to 8 special cables for the probes (provided by Ultraflux)

4.2 Choosing the measurement location

It is essential to follow the instructions given in our document "Ultrasonic transit time flowmeter". As a reminder, the main precautions to be taken are as follows:

4.2.1 Straight lengths to be used

1) Monochord measurement

Using a monochord measurement implies that the speed profile at the measuring point is symmetrical relative to the axis of the pipe, and is fully developed and stable.

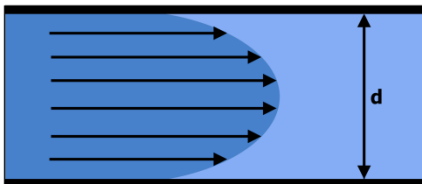

(a) Symmetrical laminar flow

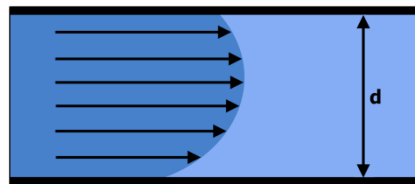

(b) Unsymmetrical laminar flow

The following three conditions are not fulfilled in an area of disturbed flow, for example, at the outlet from an elbow or downstream from a regulating valve:

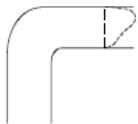

The speed profile is stable but not symmetric relative to the axis of the pipe.

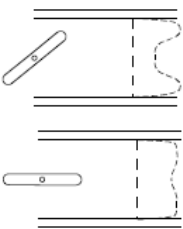

The symmetry of the speed profile varies relative to the pipe axis but is neither stable nor fully developed.

This is why probes need to be placed on a straight section of pipe sufficiently far upstream or downstream of a hydraulic disturbance (narrowing or widening of the pipe, elbow, pump, etc.).

The following values show, for liquids, the minimum distances (L) to comply with before and after a disturbance depending on the internal diameter of the pipe (D) for the errors induced by these disturbances to be less than $\pm 1\%$.

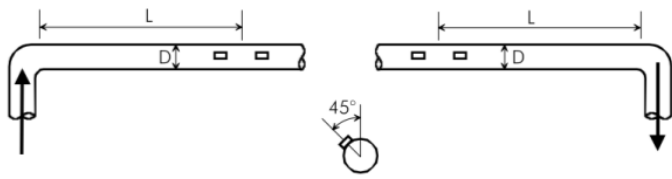

In reflex mode : $L \geq 15.D$
 In direct mode : $L \geq 20.D$

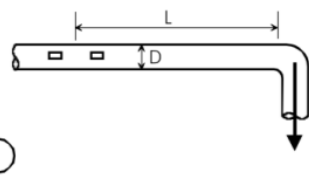

In reflex mode : $L \geq 3.D$
 In direct mode : $L \geq 5.D$

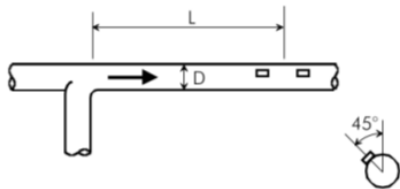
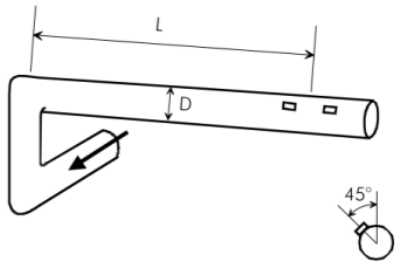

In reflex mode : $L \geq 15.D$
 In direct mode : $L \geq 20.D$

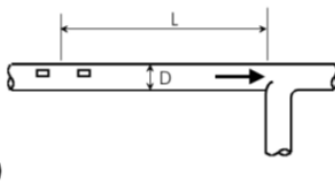

In reflex mode : $L \geq 3.D$
 In direct mode : $L \geq 5.D$

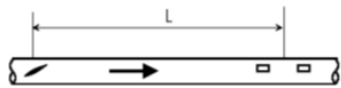

In reflex mode : $L \geq 15.D$
 In direct mode : $L \geq 20.D$

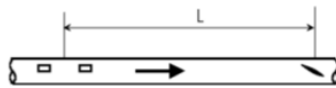

In reflex mode : $L \geq 3.D$
 In direct mode : $L \geq 5.D$

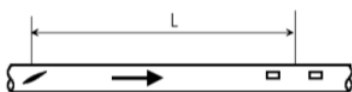

In reflex mode : $L \geq 15.D$
 In direct mode : $L \geq 20.D$

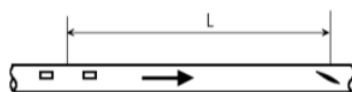

In reflex mode : $L \geq 5.D$
 In direct mode : $L \geq 8.D$

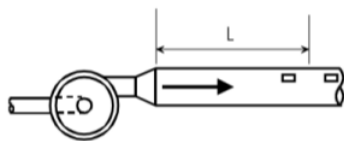

In reflex mode : $L \geq 30.D$
 In direct mode : $L \geq 40.D$

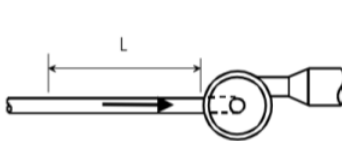

In reflex mode : $L \geq 3.D$
 In direct mode : $L \geq 5.D$

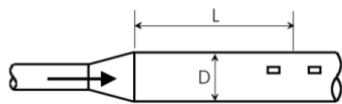

In reflex mode : $L \geq 30.D$
 In direct mode : $L \geq 40.D$

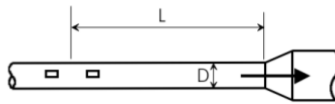

In reflex mode : $L \geq 3.D$
 In direct mode : $L \geq 5.D$

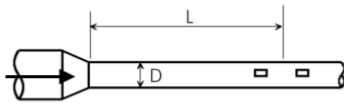

In reflex mode : $L \geq 10.D$
 In direct mode : $L \geq 15.D$

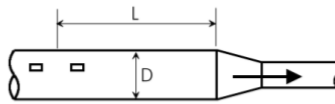

En mode reflex mode : $L \geq 3.D$
 En mode direct mode : $L \geq 5.D$

Comment:
 The values shown must be multiplied by 2.5 for gases.

2) Multichord measurement

As multichord measurement copes better with irregularities in the speed profile, multichord measurements can be used on straight lengths much smaller than those required for a monochord measurement.

For example, we have been able to test a measurement made using 4 parallel chords placed at 1.6 D from a T followed by a butterfly valve. The error under these very unfavourable conditions was 2 %. Under the same conditions, a monochord measurement would have generated an error of the order of 10 %.

Recommended locations



Vertical pipes with rising flow

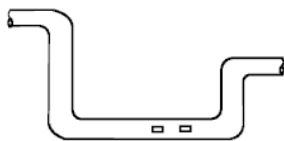

Low points of horizontal pipes



Siphon mounting for pipes with a slight slope

Locations not recommended

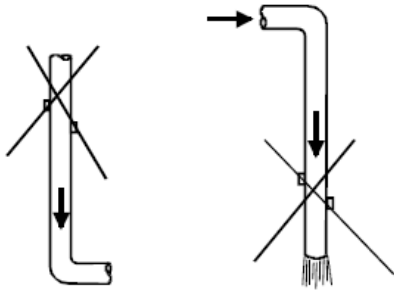

Vertical pipe with downflow, particularly in the case of free flow.

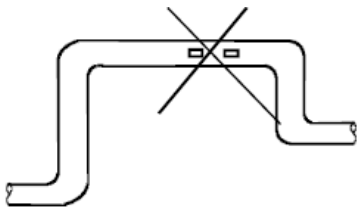

High points

4.3 Choosing the probe location

The installation depends on the type of probe.

4.3.1 Intrusive probes

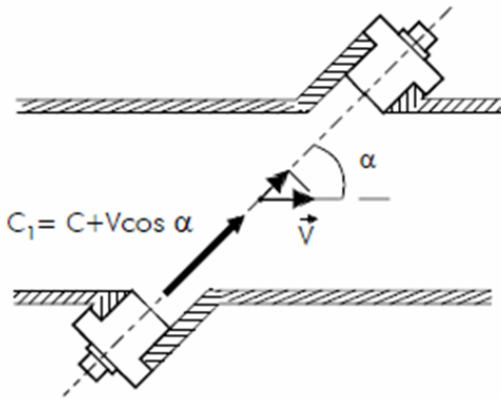

Two geometric modes may be applied:

- *Diametric mode:* The chord follows the diameter of the cross-section. An approach by Kh is then activated in order to model the speed profile and refine the measurement. The Kh coefficient takes account of the roughness of the wall and the viscosity of the fluid. You are strongly recommended to refer to the teaching manual available on request in order to understand the significance of these settings.

- *Parallel mode:* The chords are placed in parallel planes which "section" the fluid speed flow better.

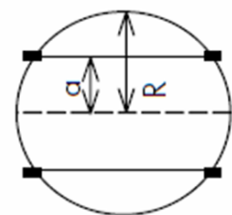

Note: The accuracy of the measurement is improved by increasing the number of chords.

Important: With a "simple" configuration, diametric mode must be used. Parallel mode is available from "normal" configuration level.

For each chord, enter the length (in meters) between the faces of the two probes. To help you, read our document "Ultrasonic transit time flowmeter".

Also enter the projected length (Daxe) of this measurement relative to the axis of the pipe.

4.3.2 External probes (clamp-on)

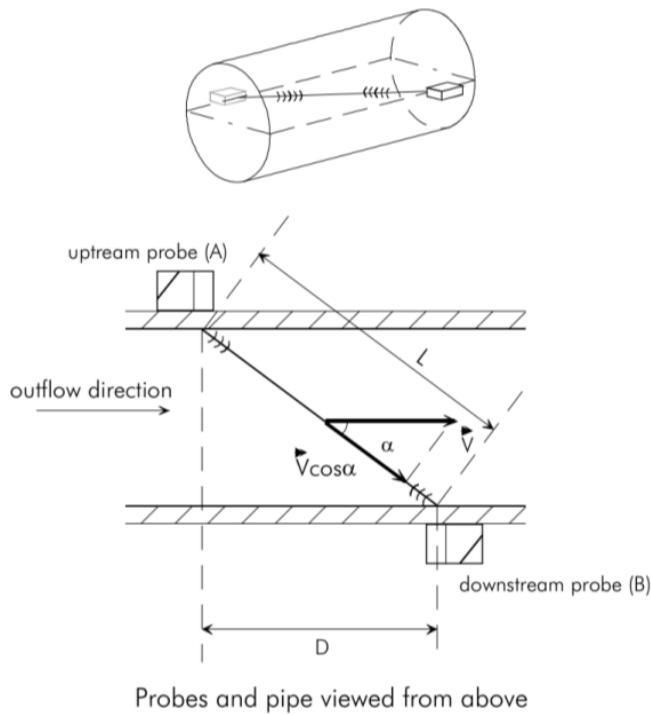

External probes may be mounted in several configurations depending on the number of ultrasound wave reflections on the wall of the pipe:

Direct or / configuration:

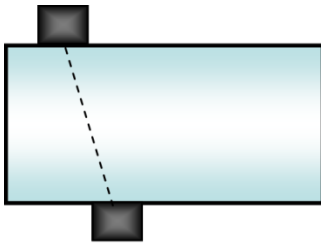

N (or Z) configuration:

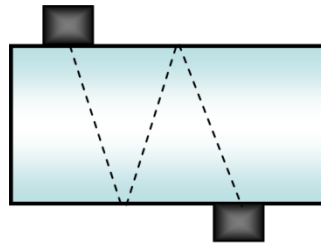

Reflex or V configuration:

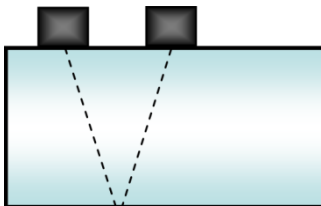

W configuration:

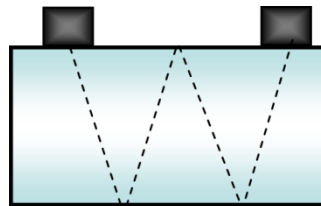

Note: The longer the travel, the more accurate the measurement.

On the other hand, the ultrasound echo will be weaker the longer the distance and therefore difficult to measure. A compromise must therefore be found between accuracy and ease of finding the ultrasounds. This compromise depends on the application (fluid, quality of the wall, diameter, etc.).

4.4 Installing probes and connectors

The care taken to install the probes (sensors) and their alignment determines the accuracy of the flow measurement.

4.4.1. Permanent external (clamp-on) probes

1) Preparing the pipe

To install external probes (clamp-on), the areas of pipe where the sensors are to be installed must have been carefully cleaned beforehand. The pipe must be cleaned using absorbent paper or a piece of cloth. If the pipe is very dirty or corroded, use a metal brush or scraper. It is not necessary to remove good paintwork. It is even recommended to keep it to avoid corrosion. The same applies to most plastic coverings. On the other hand, if the paint is blistered or flaky (test by scratching with your nail or a pointed tool), it should be removed locally.

Then coat the locations where the probes are to be installed lightly with grease (do not use silicon grease).

2) Installing the elastomer strip

To start, cut a piece of strip to the size of the probe (+5 mm).

Then remove the plastic protective film.

Apply the strip where the probe is to be installed.

Lastly, lightly grease the external surface of the strip.

3) Installing the probe

Place the probe on the strip and fix it in place by firmly tightening the stainless steel collar supplied.

Preferably position the collar locking screw on the opposite side to the probe.

4.4.2. Temporary external (clamp-on) probes

1) Preparing the pipe

To install external probes (clamp-on), the areas of pipe where the probes are to be installed must have been carefully cleaned beforehand. When doing this, take into consideration the distance between the probes and estimate the space required for probe/mounting assembly. The pipe must be cleaned using absorbent paper or a piece of cloth. If the pipe is very dirty or corroded, use a metal brush or scraper. It is not necessary to remove good paintwork. It is even recommended to keep it to avoid corrosion. The same applies to most plastic coverings. On the other hand, if the paint is blistered or flaky (test by scratching with your nail or a pointed tool), it should be removed locally.

2) Selecting and installing the coupling medium

A coupling medium must be selected which is suited to the humidity and temperature conditions of your application.

- "traditional" gel for temporary measurements at ambient temperature and without too much humidity,
- high temperature gel (<300°C),
- grease in the case of high humidity (quality depending on temperature).

After choosing a suitable coupling medium, spread it lightly around the locations chosen for installing the probes and copiously on the probes themselves.



3) Installing the probe

Attach the probes onto the pipe using straps or a dedicated support. Check the presence and continuity of the coupling medium (ensure no air layer forms between the pipe wall and the probe). To avoid this pitfall, refrain from sliding the probes too much (the coupling medium film could be altered/broken).

4.4.3. Inserted probes

Preliminary comment: before you do anything, you must check with Ultraflux whether your probes can be extracted under load or not. Whether an inserted probe may be extracted under load or not is determined by the probe used and the application conditions of your measuring point (pressure, fluid measured, etc.).

1) Flanged probes



1st step: Check the position of the bosses relative to the drawing provided by Ultraflux

2nd step: Check the state of the seal face which must be free of irregularities and dirt. Seal faces which are rusted, battered or generally in a bad state of repair must not be used.

3rd step: Insert the probe into the boss making sure the seal is present.

4th step: Insert the probe fixing screws and tighten them to the recommended tightening torques.

5th step: Connect the probes to the flow meter through the connecting head.

2) Screw probes



1st step: Check the position of the bosses relative to the drawing provided by Ultraflux

2nd step: Check the state of the seal face which must be free of irregularities and dirt. Seal faces which are rusted, battered or generally in a bad state of repair must not be used.

3rd step: Insert the probe into the boss making sure the seal is present.

4th step: Screw the probe down into the boss as far as it will go, then readjust so that the alignment marker of the probe is on the axis of its twin probe.

5th step: Carry out the previous steps from step no. 2 with the twin probe.

6th step: Connect the probes to the flow meter via the connection head or the push/pull connector (depending on the type of probe).

7th step: Readjust the alignment of the probes checking the gain displayed by the flow meter.

3) Probes with air lock



1st step: Check the position of the bosses relative to the drawing provided by Ultraflux

2nd step: Check the state of the seal face which must be free of irregularities and dirt. Seal faces which are rusted, battered or generally in a bad state of repair must not be used.

3rd step: Install the valve checking the presence of the seal. Screw the air lock onto the valve - at all times checking the presence of the seal.

4th step: Press the operating rod down as far as it will go then screw the guide into the air lock.

5th step: Orientate the packing gland in the axis of the twin probe.

6th step: Carry out the previous steps from step no. 2 with the twin probe.

7th step: Connect the probes to the flow meter via the connecting head.

8th step: Readjust the alignment of the probes checking the gain displayed by the flow meter.

CHAPTER 5: USING AND CONFIGURING THE Uf 841

5.1 Using the Uf 841

Before using the unit, the user instructions NT300, supplied with the unit, must be consulted.

The UF 841 has a screen and a keypad which can be used to configure and view the measurements as they are taken. LEDs indicate the status of the measurement and of the flow meter communication.

To access the keypad, the front cover must be opened. A fire permit may be compulsory for this type of operation. Generally, before use, please read the safety rules for the site where the machine is installed.

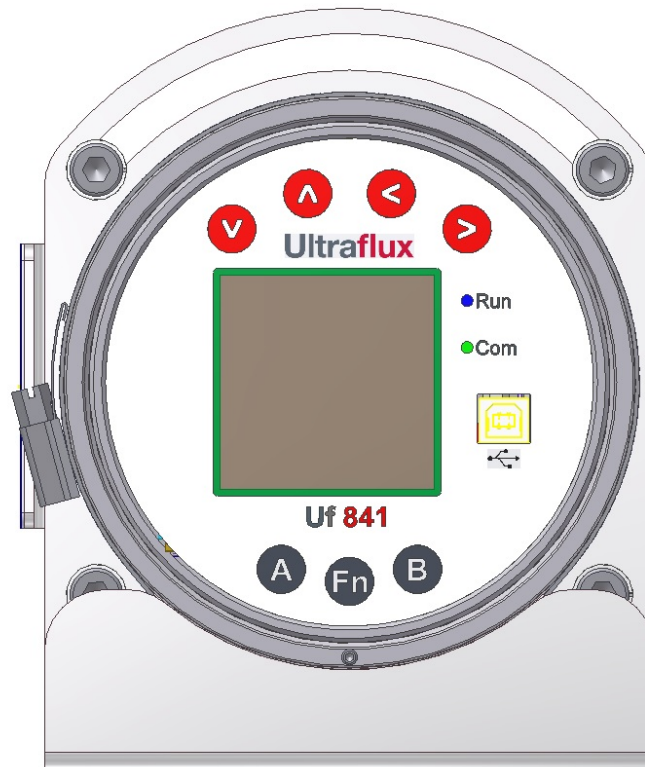

5.1.1 Operating mode

Uf 841 flow meters have 2 different operating modes:

- Measurement Mode (flow rate, velocity, gain, quality index, etc.) grouping together the measurement screens,
- Configuration Mode (section description, logger, etc.) grouping together the configuration screens as well as the echo display screens (display of electric pulses generated by the probes).

5.1.2 Keypad

The diagram below summarises the navigation procedure between the various screens and relating to the machine's "Measurement" and "Configuration" modes (including the echo display):

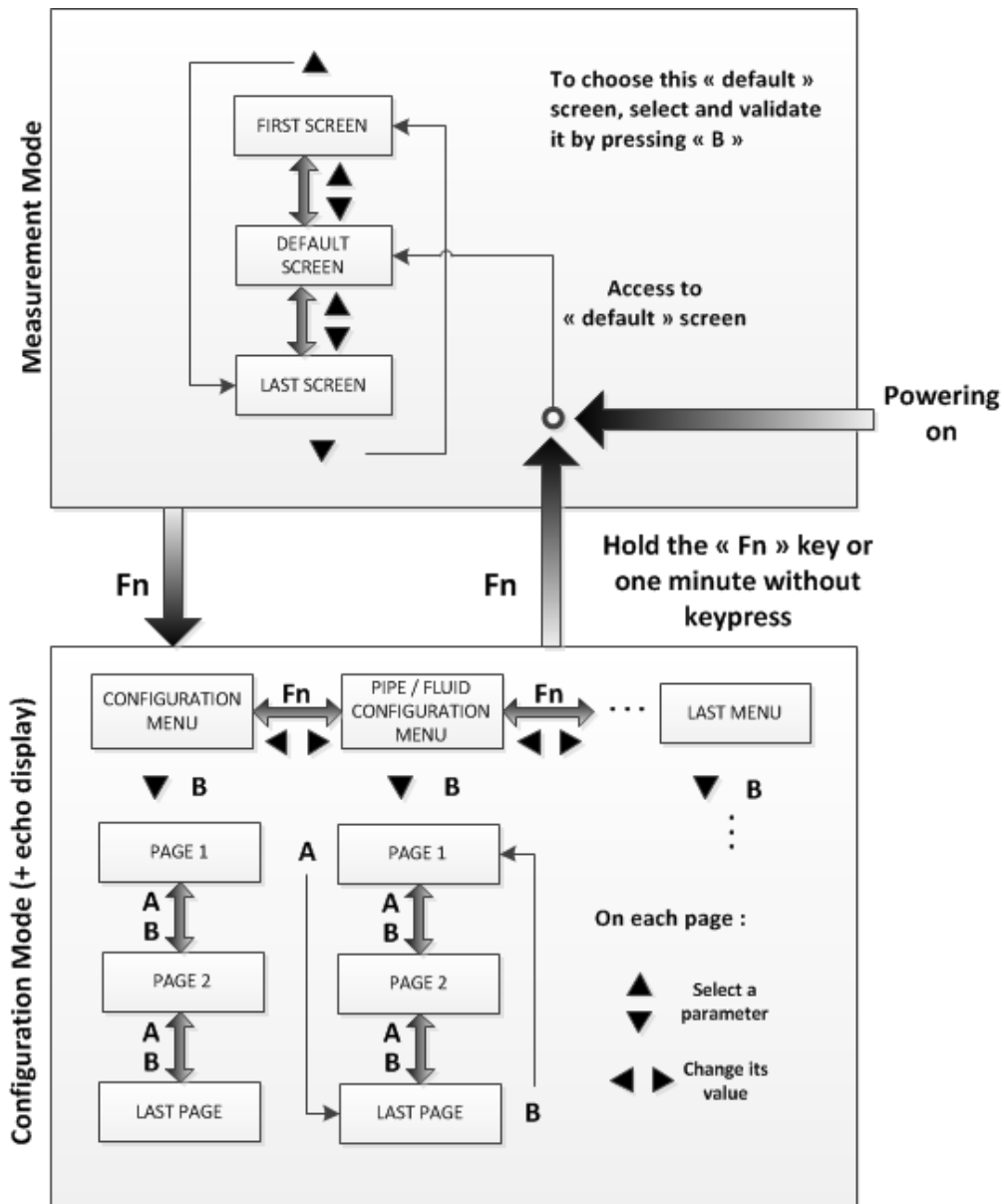

"Configuration" Mode:

- To move from one type of menu to the other, press the "Fn" (function) key or the ◀ and ▶ keys.
- To enter the first page of a menu, press the ▼ key or the "B" key. To then move down one page, press the "B" key. To move up one page, press the "A" key. To change a parameter, select it using ▲ or ▼ and change its value using ◀ or ▶.

N.B.

- If you are on the first page of a menu, pressing "A" causes selection of the last page of the menu.
- If you are on the last page of the menu, pressing "B" returns you to the first page.

- To change a parameter on a page, select it using ▲ or ▼ and change its value using the keys ► (increase) and ◀ (decrease). Pressing and holding one of these two keys accelerates the increase or decrease.

N.B.

- If you are on the first parameter of a page, pressing ▲ will send you to the last parameter of the previous page (and conversely if you were on the last parameter of the page).
- The same last page / first page loop process is carried out as for changing page using "A" and "B".
- Holding down the "**Fn**" key, or allowing approximately 1 minute to pass without using the keypad, returns you to "measurement" mode (by default, to the previously selected screen).
- Special feature of the "echo display" menu: the flow rate measurement is interrupted when the echo display is being used.

"Measurement" Mode:

- After powering on the Uf 841, the machine moves into measurement mode after a few seconds and displays the screen (or page) that was previously selected as priority. To choose this "default" screen, select and validate it by pressing "**B**" in *Measurement* mode.
- To scroll through the measurement screens, use the ▲ and ▼ keys.
- Pressing "**Fn**" switches the machine to *Configuration* mode on the "Configuration" menu.

5.1.3 LEDs

There are two LEDs on the front panel:

- *Blue measurement LED*: indicates whether or not the flow meter is measuring.
 - A flashing LED indicates normal operation.
 - An LED which is fixed on or off indicates abnormal or interrupted operation.

Warning: the flow meter may be in measurement mode (inputs-outputs, function loggers, etc.) without the probes being connected.

- *Red, orange or green communication LED*: indicates the status of the external communication of the flow meter (serial link of USB).
 - Flashing green light for each dialogue on the serial link.
 - Long red flashing light on each dialogue error on the serial link.
 - Fixed orange light when the flow calculation is in degraded mode or when a related function is faulty.
 - Fixed red light when the flow calculation is faulty.

5.2 Main configuration elements

5.2.1 Number of channels

Note: for multi-channel flow meters only, it is possible to define the number of channels to be managed by the flow meter.

The geometric and physical description of the measuring point must then be produced for each channel.

In the case of several channels, the channels are named in alphabetical order (A, B...). Q_a , Q_b ... are the flows calculated for each channel. Q_t is the total flow.

5.2.2 Description of the pipe

The pipe is described by its outside diameter (or equivalent sectional diameter) and the physical characteristics of the material(s) of which it is made.

- *In "simple" configuration:* you must define the outside diameter, the thickness of the material and the type of material. The fluid must be water.
- *In "normal" configuration:* you can choose the fluid from a list. This list depends on your flow meter type (gas or liquid).
- *In "advanced" configuration:* you can define a wall with up to 3 different materials/layers (see § 5.6.1).

Two different types of probe may be used:

- *External (clamp-on) probe:* the probe is "placed" on the outside of the pipe. The "clamp-on" probes may be positioned in direct ($/$), reflex (V), N or W configurations.
- *Intrusive mode (wet probe):* a hole must be drilled in the pipe to install the probes, or the probes must be installed directly on a sleeve (welded or fixed by flange). Intrusive probes can be placed in parallel or diametric planes.

Note: The number of chords must be chosen depending on your application and the authorised limit for your flow meter type.

5.3 Configuring the Uf 841

The configuration for the flow meter is divided into three levels:

- Simple: simplified configuration for basic use of the flow meter.
- Normal: configuration allowing more detailed use.
- Advanced: mode allowing the complete adjustment of the flow meter settings. This mode is reserved for users with detailed knowledge of the transit time difference flow measuring technique and with some idea of hydraulic concepts.

The level can be changed by selecting the menu option Configuration/Settings/Simple, Normal or Advanced:

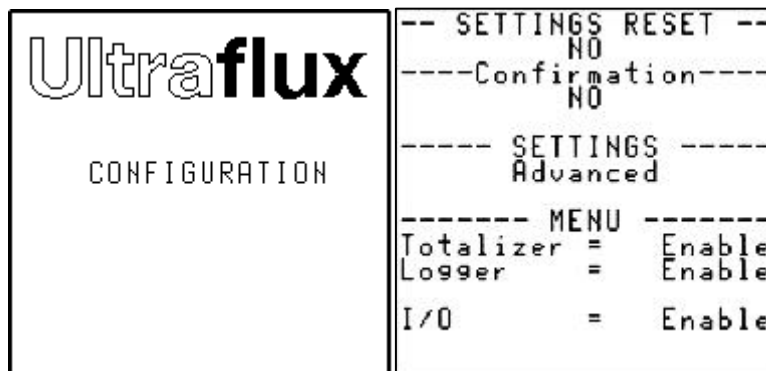

This menu is also used to activate functions such as

- the logger,
- the inputs/outputs,
- the totalizers.

To activate these options, place the cursor on the line corresponding to the required option and use the < and > keys.

5.3.1 Flow meter menu ("Settings" mode)

Depending on the type of flow meter and the configuration mode (simple, normal or advanced) selected, the flow meter menu may change. Below is a non-exhaustive list of the sections for the flow meter:

- CONFIGURATION: configuration of the operating modes, the registration name, the JBUS/MODBUS characteristics; configuration management, etc.
- PIPE/FLUID CONFIGURATION: setting of the type of fluid, the pipe, the chords, the geometry of the chords of the measuring point, etc.
- TOTALIZER CONFIGURATION: configuration of totalizers.
- INPUT/OUTPUT CONFIGURATION: configuration of inputs and outputs.
- LOGGER CONFIGURATION: configuration of the logger.
- LINEARISATION CONFIGURATION: configuration of linearisation.
- FUNCTION CONFIGURATION: settings of the inputs for the function engine. This menu is only available on request for specific applications.
- ADVANCED CONFIGURATION: settings of the simulation mode, the special probes, the specific codes for ultrasonic treatment, etc.
- ECHO DISPLAY: display of the echo signals of the ultrasonic probes.
- FIRMWARE UPDATE: update of the firmware.

5.4 SIMPLE configuration

Below you will find the description of the menus, screen by screen, to guide you through the configuration of your flow meter.

5.4.1 "Configuration" Menu

```
--- OPTION FILES ---  
  
Load Option File  
N 0:UF 8x1  
  
Save Option File  
N 0:UF 8x1
```

1) "Config. Files" Window

This window lets you load and save your configurations. The current configuration of the flow meter can be saved directly in the flow meter, or on a PC. Up to 11 configurations can be saved, numbered from 1 to 11.

To save the current configuration on the flow meter, select the configuration number under which you wish to save it. The saving of the configuration is then confirmed when passing to another menu page or following an extended press of the **Fn** key. The name of the configuration is the same as the station name (see point 8).

To recall a configuration, enter the configuration number and confirm this choice by passing to another menu page.

Remember to save the current configuration in order not to lose it.

```
-- SETTINGS RESET --  
NO  
---Confirmation---  
NO  
  
----- SETTINGS -----  
Advanced  
  
----- MENU -----  
Totalizer = Enable  
Logger = Enable  
I/O = Enable
```

2) Reinitialisation

This command reinitialises the flow meter (to factory configuration).

3) Confirmation (of reinitialisation)

Reinitialisation of the flow meter requires the user to enter a field requiring confirmation (protection against handling errors).

4) Configuration

This command allows the configuration level of the flow meter to be changed (Simple, Normal or Advanced).

5) Menus

Allow the user to enable or disable:

- the logger,
- the inputs/outputs,
- the totalizers.

```
Code access = 0
LANGUAGE : ENGLISH
-- STATION'S NAME --
   UF 8x1
---- BACK LIGHT ----
      Timed
--CONNECTION 1: PC--
N JBUS/MODBUS: 1
Bitrate : 115200
```

6) Access code

The flow meter is initially delivered without an access code (access code is 0), allowing you to freely modify all the settings. The introduction of a valid code is used to prohibit the modification of the settings for anyone who does not have the code. The settings can then be viewed freely, but cannot be modified. The code comes into operation when the flow meter returns to measurement mode. The code must be entered in order to exit this mode. If the code is incorrect, the flow meter is locked for a few seconds. The time for which the flow meter is locked increases each time that an incorrect code is entered by the user.

Notes:

- The flow meter can be locked manually. Select the "Locked" field and set it to "YES".
- The code can be modified using the keypad (it is then defined using the < and > keys) or the serial link.

Important: For writing operations via the serial link or USB, the code must be "written" before any "writing" frame. The flow meter is automatically locked after 10 seconds without any "writing". Each incorrect attempt at entering the code increases the time before the next attempt can be made.

7) Language

The possible display languages are: French, English, Spanish, German, Italian, Portuguese and Russian.

8) Station name

Each flow meter can be assigned a label with up to 8 characters (registration number). The position of the current character is chosen using the ▼ and ▲ keys. To scroll through the characters, use the < and > keys.

9) Back light

The possible options are:

- ON: the back light is on for one minute after pressing any key, then remains dimly lit,
- TEMPO: the back light is on for one minute after pressing any key, then goes off,
- OFF: No back light.

10) Link

- Configuration of the serial link
Enter the JBUS/MODBUS number of the flow meter (number assigned to the flow meter and to which it will respond on a JBUS/MODBUS query).
- Transmission speed
Enter the transmission speed that you wish to apply.

11) Timer before return to "Measurement" mode

The flow meter automatically returns to the Measurement screens after approximately one minute. The modified settings are then taken into account. This avoids the risk of forgetting to exit "Configuration" mode and needing to intervene again on the flow meter to return to "Measurement" mode.

5.4.2 "Pipe/fluid configuration" menu

In "simple configuration" mode, access to the settings is restricted to the following sections:

1) Number of chords

Enter the number of chords for your application

2) Flow rate unit (Q unit)

Enter the flow unit which will be displayed.

3) Flow graph

```
----- PIPE A-----  
Nbr of chords = 2  
-----General-----  
Q Unit = m3/h  
  
-----Graph-----  
Q Period = 1s  
Q Qmin = 0.0  
Q Qmax = 10.0
```

The flow graph is one of the Measurement screens. This shows the changes in a particular magnitude in the form of a curve (see the possible magnitudes below).

Enter the minimum and maximum limits of the dimension associated with the flow graph. These limits mark the boundaries of the vertical display of the flow graph.

The flow graph Period setting is used to define the time interval between two successive points. The possible values are: 1 s, 5 s, 10 s, 30 s, 1 min, 2 mins, 5 mins, 10 mins, 15 mins, 30 mins, 1 hr, 2 hrs, 6 hrs, 12 hrs and 24 hrs.

Example: If the period of the flow graph is 1 min, each point of the curve represents the average value of the magnitude associated with the flow graph over 1 min and the whole screen shows the evolution of the flow over the last 144 minutes.

4) Chord settings

For each chord, the two settings to be selected are the reference number of the probes used and the probe fitting type:

```

----- PIPE A -----
-----Chord 1-----
Probe      = SE1515/10
Mounting   = U

-----Chord 2-----
Probe      = SE1515/10
Mounting   = U
    
```

If the reference number of the probes you are using does not appear in the list, please contact Ultraflux.

5) Type of fluid

In "simple" configuration mode, the fluid must be water at ambient temperature (cannot be modified).

6) Definition of the pipe

The pipe diameter, thickness and material must be defined.

```

----- PIPE A -----
-----Tube-----
Ext.Diam.= 587.21mm
Ext.Circ.= 1844.77mm
-----Wall-----
Material 1= COPPER
Thick. 1= 9.25mm

Material 2= NONE

Material 3= NONE
    
```

5.4.3 "Totalizer configuration" menu (if enabled)

```
----- TOTALIZER 1 -----  
Dir.= + Value =QA  
Pulse Weight  
100 m3  
  
----- TOTALIZER 2 -----  
Dir.=OFF
```

1) Activation and counting direction

For each of the totalizers, the possible modes are:

- **OFF**: totalizer not enabled,
- **+**: totalling of the positive flows, in other words going from the upstream probes to the downstream probes (see the wiring of the probes),
- **-**: totalling of the negative flows, in other words going from the downstream probes to the upstream probes,
- **±**: totalling of all flows, whatever the direction.

Note: In addition to flow totalling, other magnitudes from the function engine may be totalled if this is enabled. Contact Ultraflux for further details on this option.

2) Pulse unit and weight

Each activated totalizer emits an incrementation pulse (which can be returned on a relay output; see section 5.4.4 - point 5) each time that the Pulse weight x Unit volume flows in the metering direction of the totalizer.

The possible units include (but are not limited to): 1ml, 1l, 1m³, 1000m³, 1Gal, 1Bbl...

3) Resetting a totalizer (if authorised)

Resetting totalizers is inhibited when the flow meter leaves the factory. On request and before shipping, it is possible to authorise the resetting of totalizers.

On site, only an Ultraflux operative will be able to reset the totalizers.

To reset a totalizer (if authorised):

1. Switch to measurement mode (long press on the **Fn** key) on the page of the totalizer concerned,
2. Press the **A** key until the totalizer that you wish to reset is displayed on the right,
3. Press the **B** key to reset the totalizer. A negative image of the pop-up menu is then displayed.

```
----- TOT1(QA +) I27  
399654510 100 m3  
  
<--> RES Tot1
```

5.4.4 "Inputs/Outputs" menu (if enabled)

The input/output modules are:

- On input:
 - Current,
 - Voltage,
 - Temperature (PT100/PT1000),
 - Contact.
- On output:
 - Current/Voltage,
 - Relay.

The menu only appears if inputs or outputs are installed on the flow meter. To install additional inputs/outputs, please contact Ultraflux to find out the specifications of all available inputs/outputs.

1) Current input and voltage input module

<pre>- INPUT/OUTPUT 2 - ---Input A 4/20mA--- Function = Simulate Value = Input 02-A 4mA = 0.350 Range = 4.000 Sim. Value = 1.875 Wiring -----> 02-A</pre>	<pre>- INPUT/OUTPUT 3 - ---Input B 0/10V--- Function = ON Value = Input 03-B 0 V = 0.000 Range = 0.061 Filter = 10 s Memory = 60 s Wiring -----> 03-B</pre>
--	---

The possible options are:

- OFF: disabled,
- ON: enabled,
- Simulation.

For ON and Simulation, the following must be defined:

- the value corresponding to 4 mA (for a current input),
- the value corresponding to 0 V (for a voltage input),
- the sensor range,
- the value to be simulated (in simulation mode),
- the value of the filter and the memory (in ON mode).

2) Temperature input module

The possible options are:

- OFF: disabled,
- PT100-PT1000 mode 2-, 3- or 4-wire (for further details, contact Ultraflux).

Define:

- the type of sensor, Pt 100 or Pt 1000,
 - the type of assembly, 2-wire, 3-wire or 4-wire,
 - the value of the filter and the memory,
 - any offset.
- Simulation: Enter the temperature value to be simulated.

3) Contact input module

The possible options are:

- OFF: disabled,
- Status: whether the contact is open or closed,
- Pulse: the number of opening - closing cycles of the contact.

4) Current/voltage output module

```
- INPUT/OUTPUT 4 -
--Analog output--
Function = 4-20mA
Value = Pipe A
4 mA = 0.000
Range = 16.000
I fault = 3.600mA
Sim. Value = 5.252mA
Wiring -----> 04-A
```

The possible options are:

- OFF: disabled,
- Voltage output:
 - 0-5 V,
 - absolute value |0 - 5 V|.
- Current output:
 - 0-20 mA, 4-20 mA, 0-24 mA,
 - absolute value |0-20 mA|, |4-20 mA|, |0-24 mA|.

For the voltage output and current output choices, the following must be defined:

- the parameter that the output represents. Select the magnitude that you wish to associate with the analogue output using the chapter headers (function) and the chapter items (value).
- the bottom of the scale:
 - value corresponding to 0 mA or 4mA (for a current output),
 - value corresponding to 0 V (for a voltage output).
- the range,
- the value in the event of a fault in mA (for a current output) or in volts (for a voltage output).

Comment: This module can be used as a current or voltage generator.

5) Relay output module

Each relay output may be configured according to one of the following operating modes:

- *Open*: The relay remains constantly off.
- *Closed*: The relay is on if the Uf 841 is powered on, and off if it is not powered on. This choice therefore allows the relay to be used to detect the presence of the power supply (positive safety).

```
- INPUT/OUTPUT 1 -  
---Relay Output B---  
Function = OPEN  
  
Rel. Stat= OPEN  
  
Wiring -----> 01-B
```

- *Totalizer*: The relay generates a pulse with an adjustable width on each incrementation of the selected totalizer.

```
- INPUT/OUTPUT 1 -  
---Relay Output A---  
Function = TOT  
Value = General  
Step = TOT1  
Step = 50 ms  
  
Wiring -----> 01-A
```

The pulse width must then be defined, determining the time for which the relay remains closed (the relay, initially off, is then on for half of the period, then off again for at least the same duration).

The value of the relay period must be less than the weight of the pulse divided by the flow rate.

Example:

Flow rate = 1000 l/s / Pulse weight = 100 l.

We therefore have 1 pulse every $100/1000 = 100$ ms.

The value of the period must therefore not exceed 100 ms otherwise not all pulses emitted by the totalizer will be counted.

- *Fault:* Depending on the polarity chosen (NO: normally open, NC: normally closed), the relay changes state when the associated fault occurs.

```

- INPUT/OUTPUT 1 -
---Relay Output B---
Function = FAULT
Polarity = NO
Value = General
QT

Rel. Stat= CLOSE

Wiring -----> 01-B

```

In the example, the variable selected is "general Q". This means that the relay closes when the flow meter is not measuring a flow and remains open otherwise.

- *Direction:* Depending on the polarity chosen (NO: normally open, NC: normally closed), the relay changes state when the sign (+ or -) of the associated magnitude changes.
- *Threshold:* Depending on the polarity chosen (NO: normally open, NC: normally closed) and the direction in which the threshold is crossed, the relay takes one state if the value is greater than the indicated threshold. The relay switches to the opposite state if the value concerned is lower than the threshold.

Comment: In order to restrict the relay backlash when the dimension concerned fluctuates around the threshold, hysteresis must be defined.

The diagram below illustrates this principle with hysteresis at 2 % and the threshold crossed in the ascending direction:

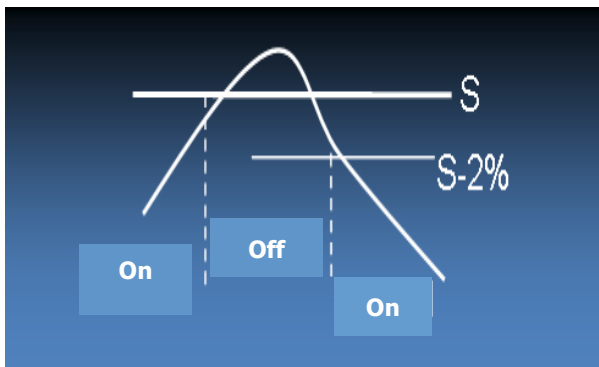

```

- INPUT/OUTPUT 1 -
---Relay Output B---
Function = THRESHOLD
Polarity = NO
Value = Pipe A
Q
Thres. Va= 57.341
Alarm = Rising
Hystérésis= 2.00%

Rel. Stat= OPEN

Wiring -----> 01-B

```

- *Frequency:* The frequency at which the relay is opened and closed depends on a value to be defined. Example: high flow, high frequency, low flow, low frequency.

```

- INPUT/OUTPUT 1 -
---Relay Output B---
Function = FREQUENCY
Value = Pipe A
Q
0 Hertz = 57.341
Range = 0.200
F fault = 0 hz
Sim. Value = 0.0Hz

Wiring -----> 01-B

```

The following must be defined:

- the parameter that the output represents. Select the magnitude that you wish to associate with the output using the chapter headers (function) and the chapter items (value).
- the value relating to 0 hertz.
- the value relating to 1 Khertz.
- the value if a fault occurs.

The relays may be tested individually: select the open or closed mode on the relay state line.

```
- INPUT/OUTPUT 1 -  
---Relay Output B---  
Function = OPEN  
  
Rel. Stat= OPEN  
  
Wiring -----> 01-E
```

5.4.5 "Logger settings" menu (if enabled)

```
----LOGGER RESET----  
NO  
---Confirmation----  
NO  
-Nbr of Parameters--  
5  
---Logger Mode----  
Cyclic  
---Logger Step----  
1mn  
---Logger Range----  
124d 7h33mn
```

Important: The logger must be reset before the number of variables is changed.

1) Resetting the logger

To reset the logger, enter "YES" in the "RESET LOGGER" field.

2) Confirmation of resetting the logger

Resetting the logger requires the user to enter a confirmation field (protection against handling errors).

3) Number of parameters for the logger

Up to 30 variables can be recorded in the logger. The number of variables can be adjusted. Its maximum autonomy is for 530,000 time-stamped readings.

4) Logger mode

The logger has 2 recording modes: "rotating" (initial files overwritten when the logger is full) or "Stop when full" (the logger stops operating when it is full).

5) Logger interval

The recording period of the logger can be set from 1s to 24 hrs: 1 s, 5 s, 10 s, 30 s, 1 min, 2 mins, 5 mins, 10 mins, 15 mins, 30 mins, 1 hr, 2 hrs, 6 hrs, 12 hrs and 24 hrs.

6) Logger autonomy

This field, which cannot be changed, shows the remaining autonomy of the logger.

7) Logger variables

For each of the variables of the logger, one of the following functions can be selected:

-----	VALUE 1	-----
General		
Status		
-----	VALUE 2	-----
Pipe A		
Q		AV.
-----	VALUE 3	-----
Pipe A		
H. water		AV.
-----	VALUE 4	-----
Pipe A		
Q		AV.

- *AVG*: average value over the recording period,
- *MIN*: minimum value over the recording period,
- *MAX*: maximum value over the recording period.

8) Log on variation

The variation mode of the logger is used to reduce the recording period for the data in the logger.

To do this, define the maximum variation percentage with regard to the previous recording. If the variation measured is greater than this maximum, recording is instantly triggered (no more than once per second).

records	Variation
= YES	
-----	VALUE 1
Pipe A	
Q	1.0%
-----	VALUE 2
Pipe A	
Q	0.1%
-----	VALUE 3
Pipe A	
Q	0.0%

Comment: A percentage equal to 0% disables the associated value.

The following figure shows the reduction in the period of the logger when the flow experiences a variation:

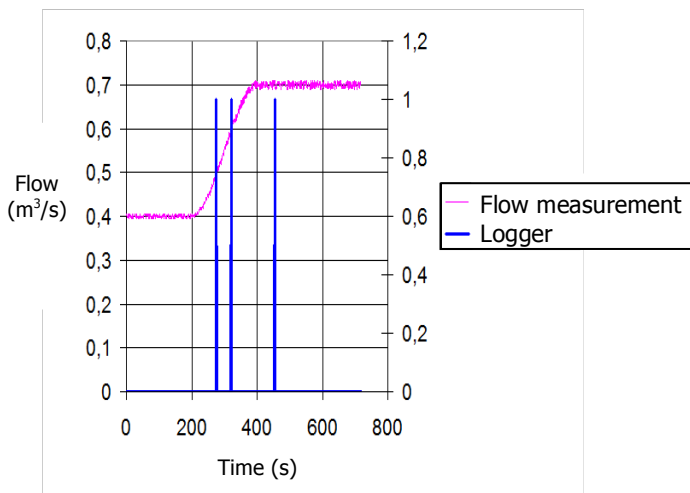

The vertical lines (blue) show when logger recording is triggered. If the variation of the flow is greater than the configured threshold, the logger forces a recording.

5.4.6 "Echo display" menu

Warning: Echo display mode blocks the measurement function (The measurement values are no longer calculated, the logger no longer records data).

"Echo analysis" mode is used to view the acoustic signal of each chord, which is of use during the commissioning or maintenance phase, or for example:

- to check the connection of the probes and that they are working correctly,
- to check that the probes are placed at the correct distance,
- to find the origin of a measurement incident (clogging of the probes, obstruction of the structure between the probes, unforeseen pollution, rupture of a probe cable, etc.).

Comment: Various characteristic signals are analysed in appendix 1.

"Echo analysis" mode includes two screens per chord:

- The first displays the acoustic signal between the emission (for short travel times) and the echo analysis zone. This screen is called the "landscape" display:

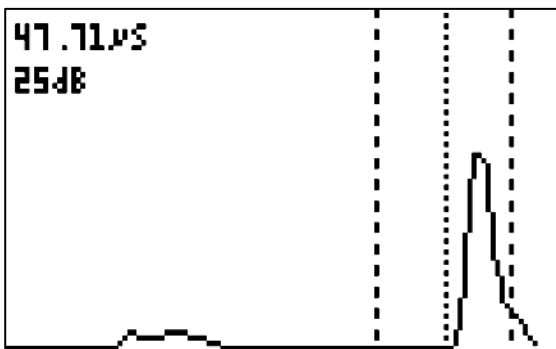

- The two dashed vertical lines show the area where the echo is expected. An echo received outside of this area will not be taken into account.
- The dotted vertical line shows the measuring point on the echo.
- The chord number is shown underneath the graph.
- On the top left of the screen is shown the gain applied to the echo and the travel time of the wave.

Comment: If no acoustic signal reaches the expected zone (for example if one of the probes is not connected, or if one of the probe cables is damaged), the screen displays a "!" sign in place of the acoustic signal.

- The second screen shows a zoom on the echo chosen for the measurement. This screen is called the "zoom display":

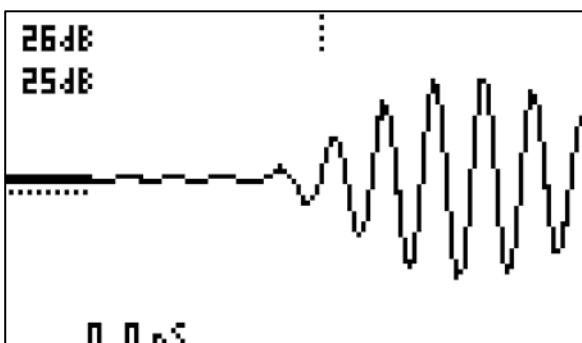

- The continuous horizontal line shows the noise level.
- The vertical dotted bar marks the location where the travel time is measured. Its absence means that no measurement was carried out (for example if there were too many interfering signals).
- The horizontal dotted bar shows the measurement threshold. The measurement is carried out on the first movement to 0 of the cycle which crosses this threshold.
- On the bottom left is shown the travel time difference of the ultrasounds (does not include ΔT_0).

5.5 NORMAL configuration

Comment: The following description will be restricted to the additional functions of normal configuration as compared with simple configuration. The common base already explained in the simple mode section is not repeated in this section.

5.5.1 "Pipe/fluid configuration" menu

1) Memory

The memory time is the time, given in seconds, for which the measurement is stored in memory when a measurement is lost (echo loss).

This memory time is used in particular to avoid untimely actions from the instrumentation and control part of the installation.

Two situations may arise:

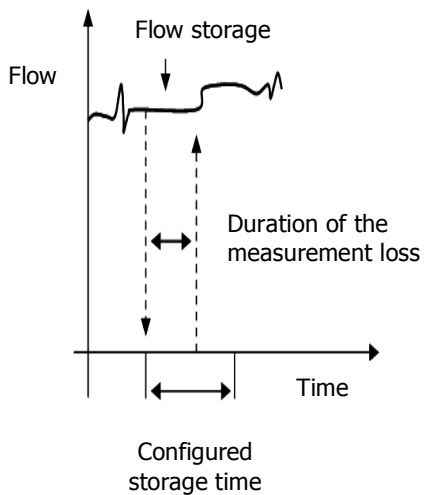

Case no. 1: Duration of the measurement loss less than the memory time. In this case, the flow meter holds the last measurement until a new valid measurement is obtained.

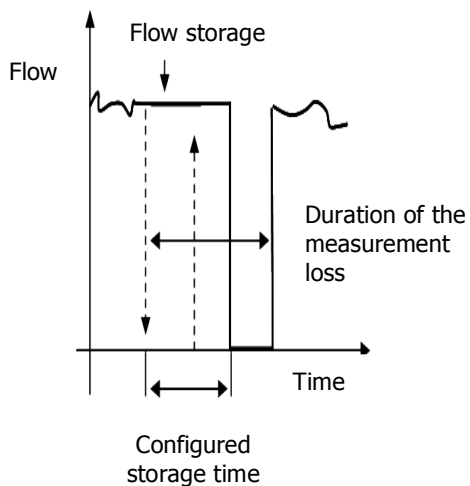

Case no. 2: Duration of the measurement loss greater than the memory time. The flow meter extends the last measurement until the elapsed time exceeds the memory time. Then the flow metering system faults itself if there are still no new valid flow rate measurements.

2) Filter

The flow measurement can be filtered so as to make the measurement results more legible.

```
----- PIPE A-----
Nbr of chords = 2
-----General-----
Q Unit = m3/h
Memory = 10s
Filter = 10s
DeltaQ Fil. = 5.000m/s
-----Graph-----
Q Period = 1s
Q Qmin = 0.0
Q Qmax = 10.0
```

This feature must be used when the flow is extremely chaotic and an average for the flow needs to be produced in order to view its evolution.

The diagram below illustrates the effect of the filtering in the event of a very versatile and turbulent measurement:

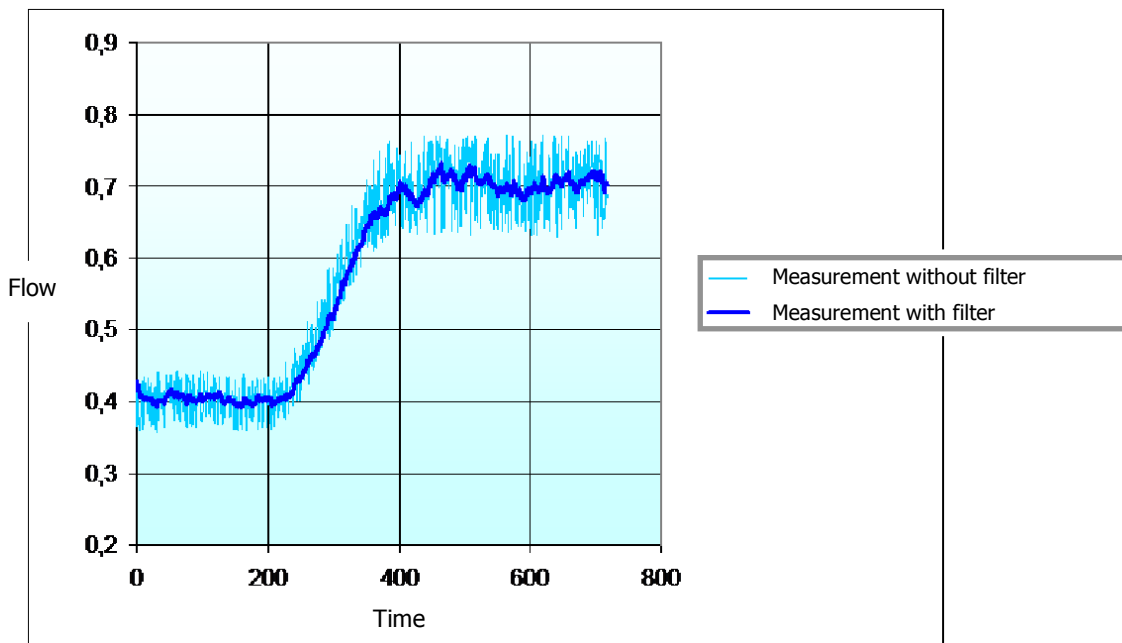

The filter time constant, given in seconds, defines the "force" of the filtering: following a flow rate step (quick opening of the isolation dam), the value measured reaches the final value at 1% after the time constant.

To adjust this time constant, a simple rule involves taking as the time constant a value equal to two or three times the foreseeable duration of any interference: for example, if you wish to avoid seeing flow variations quicker than every 20 seconds, give the time constant a value of 40 or 60 s.

However, you must ensure that the time constant is not too large, since this would risk masking significant events.

3) Delta T0 and Auto zero

```
----- PIPE A-----
-----Chord 1-----
Probe      = SE1515/10
Mounting   = 0

Ext.Coef.  =  AUTO.

DeltaT0    =  0.00ns
Seek Gain  =  30dB
Gain Max   =  96dB

----- PIPE A-----
-----Fluid-----
Product    =
           =  water (20 C)
C0         =  1482m/s
DeltaC     =  388m/s
KH Type    =  AUTO.
Viscosity  =  1.00Cst
Roughness  =  0.10mm
Reynolds C =  2800
LBR        =  3.000

-----Calibration-----
CutOff Q.  =  0.01m³/h
Autozero   =  NO
```

The DeltaT0 field is used to correct installation errors. For example, it is possible to compensate for a bias due to an incorrect position of the probes by adding to DeltaT0 the value required in order to rectify it.

It is also possible to launch an automatic determination mode for the Delta T0 by selecting a time (30 s, 1 min, etc.) in "Autozero". **Warning:** before doing this, ensure that the pipe is definitely at rest.

4) C0 and Delta C

With a "normal" configuration, it is possible to select a fluid and its associated celerity from a non-exhaustive list. The celerity relating to the selected fluid is displayed automatically in the C0 field. If a fluid not shown in the list, you can select "Product = OTHER" and define a special C0 value (the C0 field becomes editable).

```
----- PIPE A-----
-----Fluid-----
Product    =
           =  water (20 C)
C0         =  1482m/s
DeltaC     =  388m/s
KH Type    =  AUTO.
Viscosity  =  1.00Cst
Roughness  =  0.10mm
Reynolds C =  2800
LBR        =  3.000

-----Calibration-----
CutOff Q.  =  0.01m³/h
Autozero   =  NO
```

The Delta C is used to indicate to the flow meter the variation in the speed of the sound and therefore the "search" area for the ultrasound echo. To use this variable, it is preferable to use the standard settings and launch the echo display (see the "Echo display menu" section).

If the echo is outside the search window, you can:

- change the C0 to re-centre the window,
- change the Delta C to widen or shorten the search window.

If the echo is on the right, the value of C must be lowered.

Conversely, if the echo is on the left, the value of C must be increased.

5) KH

The hydraulic coefficient KH is used with external probes (clamp-on or diametric intrusive). It is used to determine the speed throughout the cross-section of the pipe from the average speed over a diameter. Its value therefore depends on the speed and the flow conditions (laminar or turbulent).

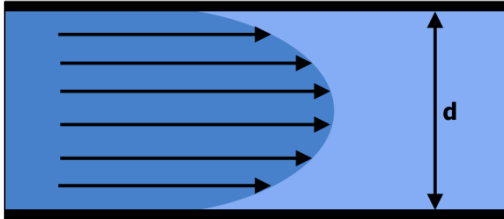

(a) Laminar flow

(a) Laminar: The fluid veins are parallel to the axis of the pipe. This results in a parabolic speed profile.

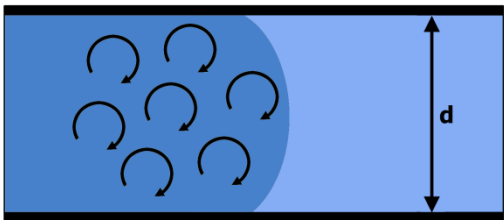

(b) Turbulent flow

(b) Turbulent: The fluid veins are not parallel to the axis of the pipe. This results in a "rectangular" speed profile.

The KH can be calculated automatically ("Type KH = AUTO") or set manually.

```
----- PIPE A -----  
----- Fluid -----  
Product =  
      water (20 C)  
C0      = 1482 m/s  
DeltaC  = 388 m/s  
KH Type = AUTO  
Viscosity = 1.00 Cst  
Roughness = 0.10 mm  
Reynolds C = 2800  
LBR      = 3.000  
----- Calibration -----  
CutOff Q. = 0.01 m3/h  
Autozero  = NO
```

In automatic mode, the viscosity of the fluid and the roughness of the inside of the pipe must be defined.

In manual mode, you can define the KH yourself (if you have a good understanding of the flow rate in your pipe).

6) Deletion rate (Q_{eff})

The deletion rate is the flow rate below which the flow meter will display 0. This gives you a clear indication of a flow rate considered to be null.

5.6 ADVANCED configuration

Comment: The following description will be restricted to the additional functions of advanced configuration as compared with the configurations defined previously (simple and normal). The common base already explained above in this document is not repeated in this section.

5.6.1 "Pipe/fluid configuration" menu

1) Delta V filtering

When a filter has been activated, it is possible to request that the flow meter disables the filter if the measurement changes very quickly. This provides a filter which is sufficient to comfortably see the change of the measurement and to retain reactivity while not filtering large variations in velocity:

```
----- PIPE A-----
Nbr of chords = 2
-----General-----
Q Unit = m3/h
Memory = 10s
Filter = 10s
DeltaU Fil. = 5.000m/s
-----Graph-----
Q Period = 1s
Q Qmin = 0.0
Q Qmax = 10.0
```

2) Material of the pipe wall

In Advanced mode, you can define the wall through 3 different materials/layers. On the image below, **#1** is the external material/layer, **#2** and **#3** follow in order towards the inside of the pipe. The materials/layers are deactivated if **NONE** is selected on the material line. To activate a material/layer, choose the material and adjust its thickness. All type of material/layers can be used as long as they can transmit ultrasounds. If you cannot find your material in the predefined list, select **OTHER** and enter in addition of the thickness your material's speed of sound.

```
----- PIPE A-----
-----Tube-----
Ext.Diam. = 587.21mm
Ext.Circ. = 1844.77mm
-----Wall-----
Material 1 = COPPER
Thick. 1 = 9.25mm
Material 2 = NONE
Material 3 = NONE
```

3) Laminar/turbulent transition

We have previously mentioned in this document the flow type (laminar or turbulent) for the calculation of KH. In "Advanced" configuration mode, you can change part of the KH calculation mode by defining the laminar/turbulent transition point.

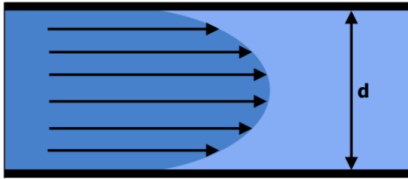

(a) Laminar flow

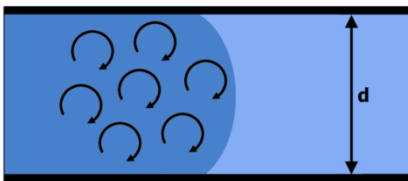

(b) Turbulent flow

```

----- PIPE A -----
----- Fluid -----
Product =
      water (20 C)
C0      = 1482m/s
DeltaC  = 388m/s
KH Type = AUTO.
Viscosity = 1.00Cst
Roughness = 0.10mm
Reynolds C = 2800
LBR      = 3.000
----- Calibration -----
CutOff Q. = 0.01m³/h
Autozero  = NO
  
```

The transition between the two types of flow varies according to the case and the measurement points. It is possible to change the configuration of this transition within the flow meter by changing the critical value of the Reynolds number (Reynolds number at which the flow transition occurs) and width LBR of the transition.

Comment: The higher the LBR, the more abrupt the transition.

4) Seek gain and Gain max

The gain is the parameter which determines the amplification of the ultrasonic signal required for the flow meter to take a measurement. If the flow meter needs to increase the gain, this means that the ultrasonic signal received is very weak. The poorer the quality of the signal, the greater the gain and the more difficult it is to measure the flow.

```

----- PIPE A -----
----- Chord 1 -----
Probe   = SE1515/10
Mounting = U

Ext.Coeff. = AUTO.
DeltaT0   = 0.00ns
Seek Gain = 30dB
Gain Max  = 96dB
  
```

Using the maximum gain setting, you can reject measurements if the gain exceeds the value entered in the flow meter.

Important: You are strongly advised to contact Ultraflux before modifying these settings.

5) Weighting coefficients of the chords

The chord weighting coefficient is only useful for parallel intrusive probes. It is a correction factor for each chord applied to the speed before the overall calculation of the flow rate in the pipe from the weighted speeds of all the chords:

$$Q = \frac{\pi D^2}{4} * \sum C_i * V_i \quad \text{where } C_i \text{ are the weighting coefficients and } V_i \text{ the measured ultrasound speeds.}$$

These coefficients are fundamental for a measurement using parallel chords. They are predetermined according to the number of chords:

	a / R	C _i
2 chords	+ and - 0.5	0.5
4 chords	+ and - 0.3090	0.3618
	+ and - 0.8090	0.1382

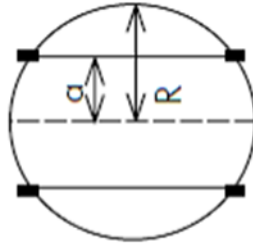

Please feel free to contact Ultraflux to determine the value of the weighting coefficients.

5.6.2 "Linearisation settings" menu

One last action possible on the flow is the linearisation of the result. Depending on the flow, the flow is corrected by X% based on a pre-defined table:

-QA			+QA		
Q ref=		Ø (m³/h)	Q ref=		Ø (m³/h)
Coef. 0 %	=	1.0000	Coef. 0 %	=	1.0000
Coef. 10 %	=	1.0000	Coef. 10 %	=	1.0000
Coef. 20 %	=	1.0000	Coef. 20 %	=	1.0000
Coef. 30 %	=	1.0000	Coef. 30 %	=	1.0000
Coef. 40 %	=	1.0000	Coef. 40 %	=	1.0000
Coef. 50 %	=	1.0000	Coef. 50 %	=	1.0000
Coef. 60 %	=	1.0000	Coef. 60 %	=	1.0000
Coef. 70 %	=	1.0000	Coef. 70 %	=	1.0000
Coef. 80 %	=	1.0000	Coef. 80 %	=	1.0000
Coef. 90 %	=	1.0000	Coef. 90 %	=	1.0000
Coef. 100 %	=	1.0000	Coef. 100 %	=	1.0000

The parameter Q ref defines the maximum flow used for the linearisation. The points of the table are then defined as a percentage of this maximum.

The rectifier coefficient must be defined by the user:

- A coefficient of 1 does not change anything in the result.
- A coefficient of 0.8 reduces the value of the flow by 20% at this point, etc.

There are two tables, one for positive flows and one for negative flows.

5.6.3 "Advanced settings" menu

1) Simulation mode

```
----- PIPE A-----  
Function = Measure
```

The flow meter can be used:

- in Measurement mode (normal operation of the flow meter),
- in Flow simulation mode.

Enter the value of the flow required and the sine wave (as a percentage) applied around this value.

Comment: A modulation of 0% keeps the flow velocity constant. A modulation of 100% fluctuates the simulated flow between 0 and 2 times the indicated value.

2) Special probes

It may be necessary in certain cases to define a probe which is not referenced in the list of Ultraflux probes. Before using this option, you are strongly recommended to contact Ultraflux.

To use probes other than those of Ultraflux, use the "special probes" function.

```
-- SPECIAL PROBES --  
-----Probe SA-----  
T0 = 0.00µs  
F = 2Mhz  
Angle= 0.00  
Text =SA  
  
-----Probe SB-----  
T0 = 0.00µs  
F = 2Mhz  
Angle= 0.00  
Text =SB
```

T0 represents the dead time of the probe.

F represents the frequency of the probe.

Angle relates to the angle of the ultrasound probe. For an open channel probe, the angle is always 0.

Text is used to identify the special probe in the list of references of accessible probes.

3) US & TRT processing

These settings allow the Ultraflux teams to adapt the operation of the flow meter to a specific case. You must consult us before any modification of these settings.

5.6.4 "Firmware update" menu

This option is used to update the flow meter without needing to dismount it. Consult us prior to using this option.

5.7 "Measurement" mode

The flow meter has measurement pages (different values are displayed on successive pages) including a flow graph.

5.7.1 Pages available

The Measurement screens provide a large amount of information: to scroll through and access the pages, use the ▲ and ▼ keys.

The same information is displayed for each of the chords of the application:

1) Flow

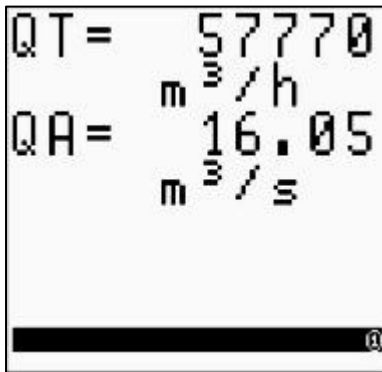

This page displays the flow measured with the unit.

2) Pipe measurements

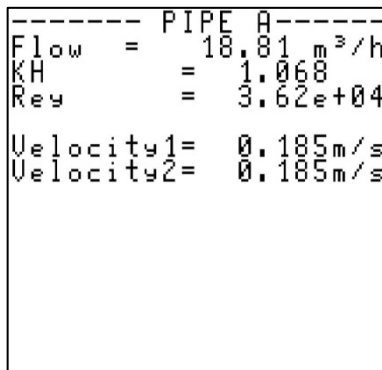

This page displays the data relating to the flow: flow rate, measured Reynolds number, calculated KH, average speed in the pipe, etc.

3) Specific information relating to the chords

These pages (which depend on the number of chords) provide information on the specific measurements for a chord:

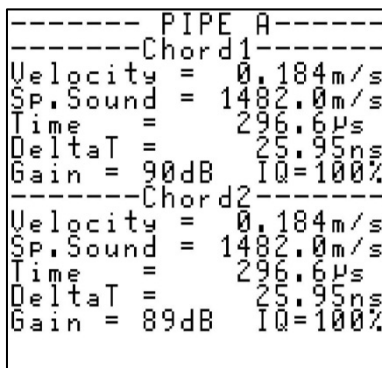

- average time (average of the time for the upstream-downstream journey and the time for the downstream-upstream journey),
- delta T (difference between the upstream-downstream journey time and the downstream-upstream journey time),
- measurement gain (the higher the gain, the more difficult it is to obtain a measurement),
- IQ quality index (100% indicates a very good measurement, 0% indicates that the measurement is not possible).

4) Totalizers

```
---- TOT1(QA +) T27
399654510 100 m³

<--> RES Tot1
```

This screen indicates the metering status of the totalizers and allows them to be reset (if authorised).

5) Date and time

```
24/04/2012 13h59mn19
----Power Off-----
24/04/2012 10h39mn24
-----Power On-----
24/04/2012 10h47mn01
Pipe All All
```

This screen shows the date and time of the flow meter and the information relating to when it was last powered on.

Information for Ultraflux use only.

6) Info logger

```
--- INFO. LOGGER ---
- Max nbr of records -
  178968
- Nb written records -
  235
--- Last record ---
24/04/2012 13h59mn34
```

This page shows the status of the logger and the last recording made.

7) Events

```
----- FAULTS -----
-----General-----
```

These pages are used to find out whether there is a problem on the flow meter and to localize it in order to resolve it.

```
----- FAULTS -----
----- PIPE A -----
```

8) Distance between probes

```
----- PIPE A-----  
-----Chord1-----  
Probe      = SE1515/10  
Mounting   =      0  
D.Probe    =      158mm  
  
-----Chord2-----  
Probe      = SE1515/10  
Mounting   =      0  
D.Probe    =      158mm
```

These pages (which depend on the number of chords) provide the reference of the associated probes for each chord.

For external probes, this screen also shows:

- the installation type (direct/reflex),
- the required distance between the probes.

9) Flow graph

The flow graph is a screen which shows the changes in a particular magnitude in the form of a curve.

5.7.2 Verification of the quality and consistency of the measurement

The information from the various pages in the "measurement" mode allow you to check whether your measurements are consistent.

The gain and IQ (Quality Index) values also provide you with information on the quality of your measurement.

CHAPTER 6: FUNCTION ENGINE

6.1 Principle

Each Uf 841 includes a miniature PLC. This PLC allows Ultraflux to easily install additional features for this flow meter.

On request, Ultraflux can quickly integrate a new feature for your Uf 841.

6.2 Application examples: Calorimetry

6.2.1 Water temperature calculation

The water temperature can be determined from its celerity (via a calculation).

You will find in the appendix the polynomial used to determine the temperature of the water based on the celerity measured by our flow meters.

The function engine allows us to carry out this calculation internally in the flow meter.

6.2.2 Calorimetry

It is possible to measure the heat flow of an installation.

If a cold temperature measurement and hot temperature measurement is combined with the flow rate calculated by the flow meter, the heating power expended can be measured.

The diagram below shows a typical measuring point for this application:

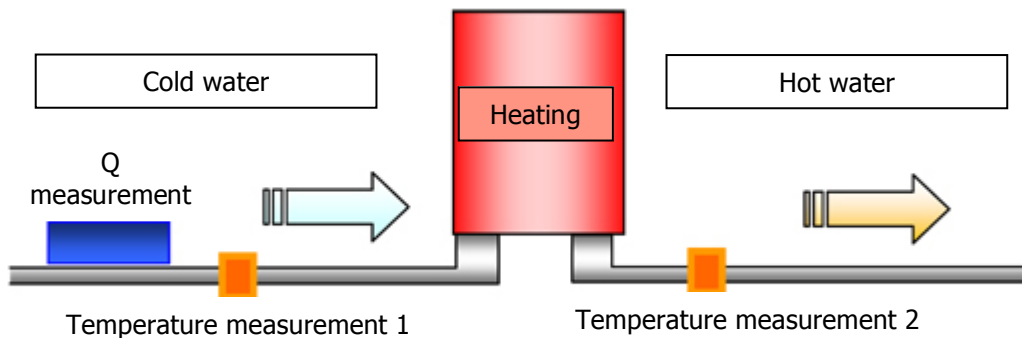

The following graph illustrates a measurement result typical of the application of calorimetry, the values displayed being:

- the temperature difference between the probes,
- the instantaneous heating capacity,
- the kWh totalizer.

Caloric heat flow measurement on a heater

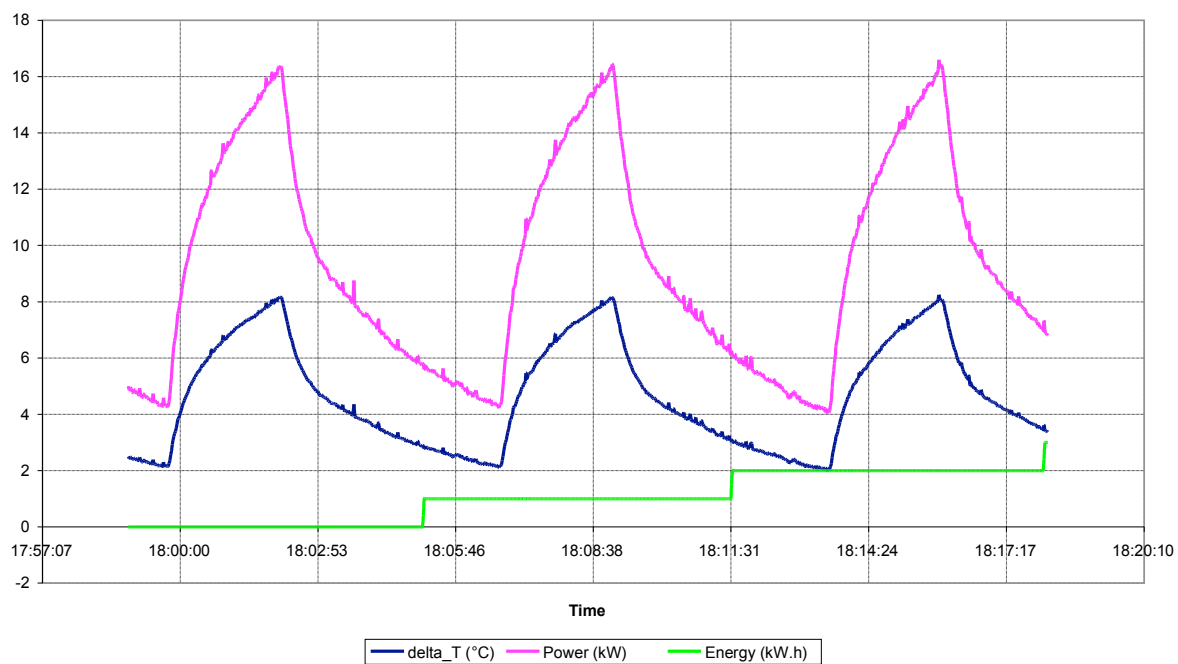

6.3 Application examples: Conversion of gas flow rate into standardised flow rate

The flow meter measures the gas flow rate in a standard unit (m^3/h , m^3/s , etc.). In the gas industry, the standardised flow rate is commonly used as a unit (Nm^3/h , Nm^3/s , etc.) and is calculated according to the gas pressure and temperature. The standard used for this unit conversion is ISO 2533.

6.3.1 Integration of pressure and temperature

As standard, the temperature should be entered into the machine manually via the "function settings" menu.

As an option, the temperature and pressure may be integrated via an analogue input. This is an option to be requested at the time of ordering and involves the addition of an analogue input in the flow meter.

6.3.2 Reading the standardised flow rate

The standardised flow rate is displayed in the "measurement menu".

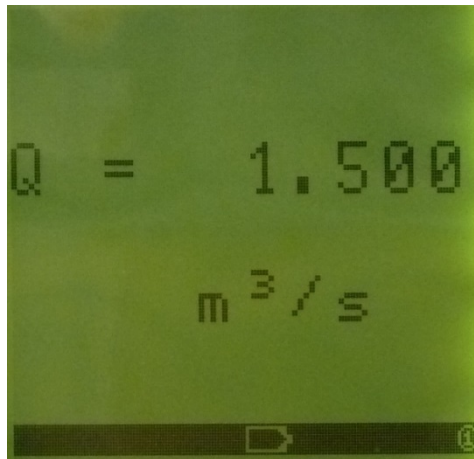

Non corrected standard flow rate

This page gives the standard flow rate measured by the machine. Use the up and down navigation keys to display the standardised flow rate page.

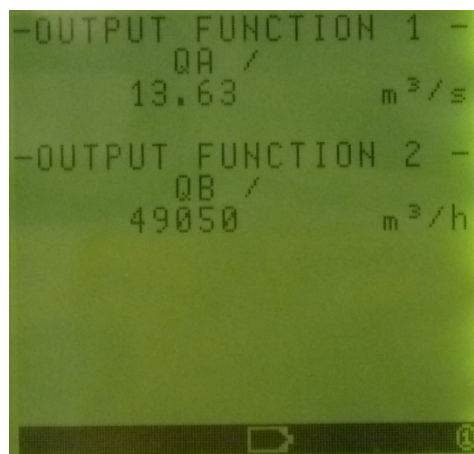

Standardised flow rate

The standardised flow rate is given in Nm^3/s or Nm^3/h .

CHAPTER 7: PC SOFTWARE

7.1 Introduction

The PC software is used to configure the flow meter using a PC, rather than accessing the parameters using the keypad of the flow meter.

It is used in particular:

- to define all settings for the application,
- to monitor, in real time, the measurement parameters (flow, average velocity, speed of sound and gain for each chord, etc.),
- to save the measurement or settings data in a file for later consultation,
- to download, using the serial link or USB, the flow meter operation settings, the measurement data, the logger,
- to print the displayed data,
- to transfer the measurement and logger data to a spreadsheet program.

The minimum PC configuration required is a PC with a Windows version later than Windows XP.

7.1.1 Installing and running the software

To install the software:

1. Run the Setup.exe installation program included on the CD-ROM,
2. Select the language to use for the installation and for displaying the screens,
3. Using the Browse button, specify the software installation path (by default C: \ Program Files \ Ultraflux \ [PC software corresponding to your flow meter].x, with x designating the version no.).

Comment: For an identical reinstallation of the program (for example in the event of damage to the execution file) or to uninstall it, select the program from the list of installed programs (Start / Settings / Configuration panel / Add/Remove programs) and click the Add/Remove button.

A window asks you which action you wish to carry out: Change (function not available for the software, since it only contains a single component), Repair or Remove.

The program is run by double-clicking the icon  associated with the software and placed on the desktop, or by selecting the program via Start \ Programs \ Ultraflux \ software corresponding to your flow meter.

The options proposed by the 4 main menus are:

- "File" menu – to:
 - Open a measurement, configuration or logger file (using the "open" command),
 - Create a configuration file (using the "new" command),
 - Close the program (using the "exit" command).

- "Dialogue" menu (with the flow meter) – to:
 - Call up the measurement window,
 - Call up the settings window,
 - Change the access code,
 - Download logger data from the flow meter to the PC,
 - View the echo display,
 - Save all settings of the flow meter.

- "Configuration" menu – to:
 - Configure the PC software,
 - Load the configuration file,
 - Save the configuration file.

- "About" menu – to:
 - Obtain information on the version of the PC software.

7.1.2 Connecting the flow meter to the PC

To connect the Uf 841 to the PC, you must connect the lead provided (serial link or USB cable). The exchanges are made in the JBus/ModBus protocol, the PC being the master and the Uf 841, identified by its number, being the slave.

7.1.3 Home page

When run, the software displays the following window:



This window contains 4 main menus:

- "File",
- "Dialogue",
- "Configuration",
- "About".

First open the Configuration menu to define the settings relating to your application.

7.1.4 Configuration window

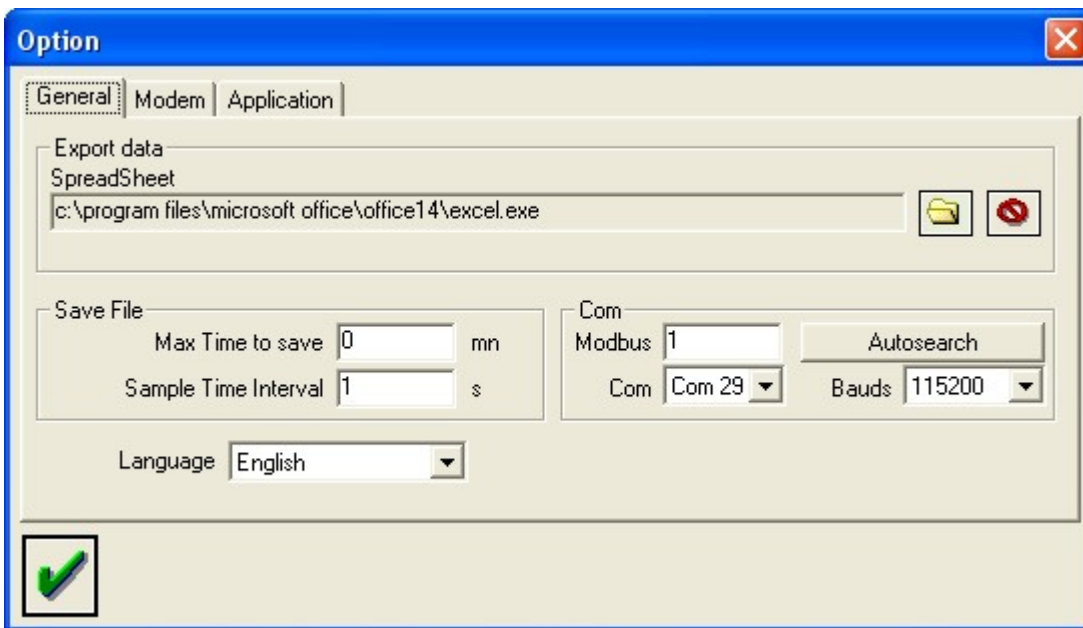

The window opened by the Configuration menu is used in particular to select the display language and to define the path of the software used to work with the data (Excel by default, if this is installed on your computer).

It also includes a **"Autosearch" button** used to automatically detect the presence of an Ultraflux flow meter.

Comment: To use the serial link, the transmission speed can be set from 300 to 115,200 bauds, the fastest speed being preferable, especially for data-logger downloads.

7.1.5 Icons

Icons are displayed at the bottom of each window of the "Dialogue" Menu (with the flow meter).



This icon in the form of a disk runs the save procedure. The software then asks you for the name of the folder in which to save. You can then read, print or handle in Excel (or the data processing software) these records using the command File / Open / [save name].

Comment: When measuring, once the saving process has started ("Save" button), the data is saved at the pace established by the period entered in the configuration menu of the software, up to the set time. When Time = 0, it is stopped manually.



This icon is used to print all data displayed on the screen.



This icon launches the data transfer procedure from the PC to the flow meter.

7.1.6 File menu

The File menu allows you to open a saved file ("Open" command), or prepare a settings file offline ("New" command). Once the file is saved, you can export it to a Uf 841.



7.1.7 Measurement window

The measurement window is opened using the Dialogue/Measurement command.



1) List of available tabs

The (measurement) window contains the following tabs:

- "General" tab: contains the general information on the measurement.
- "QA" (flow rate) tab: contains the general information concerning the measurement channel.
- "Input/output" tab: contains the general information on the inputs/outputs.
- "Function" tab (optional): contains configuration data for the function engine if this is used (this tab only appears if at least one output from the engine is configured).

2) "General" tab

This tab displays the main information about the measurement: graphic display of the measurement, instant values of the flow rate and flow velocity, totalizers.

The screenshot shows the 'Measurement' window with the following data:

- General Tab:** QA | Function | Input-output 01-04
- Timestamp:** 02/05/2012 - 17:01:23
- Defaults:** (Empty field)
- Totalizer(s):** Tot. 1 : QA (+) 399737962 x 100 m3
- Flow Rate:** QA 19.49 m3/h
- Flow Velocity:** 0.021 m/s
- QT:** 19.49 m3/h
- Flow Rate Graph:** 10.0 m3/h (top), 0.0 m3/h (bottom)
- Device Information:**
 - Version: (Empty)
 - Unit Name: UF8xx
 - Type: 2 Pipes
 - Firmware: 26-15-05-A(862*) | 00-72-05-K.d(860*)
 - Serial Nbr: 40/11/0069 | Hardware: MK6-G

3) "QA" tab (flow rate)

This tab displays the main information concerning the measurement channel: graphic display of the measurement, instant values of the flow rate and flow velocity and KH; information related to the measuring chords.

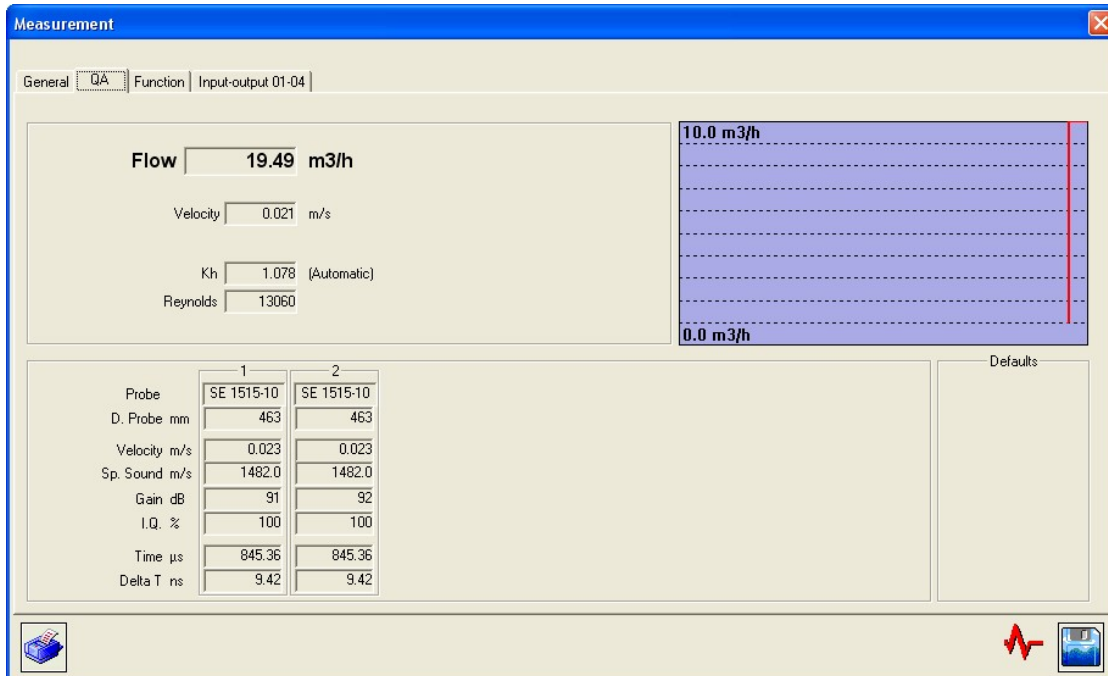

Comment: There are as many tabs as there are pipes configured.

4) "Inputs/outputs" tab

This tab displays the information concerning the inputs/outputs of the flow meter.

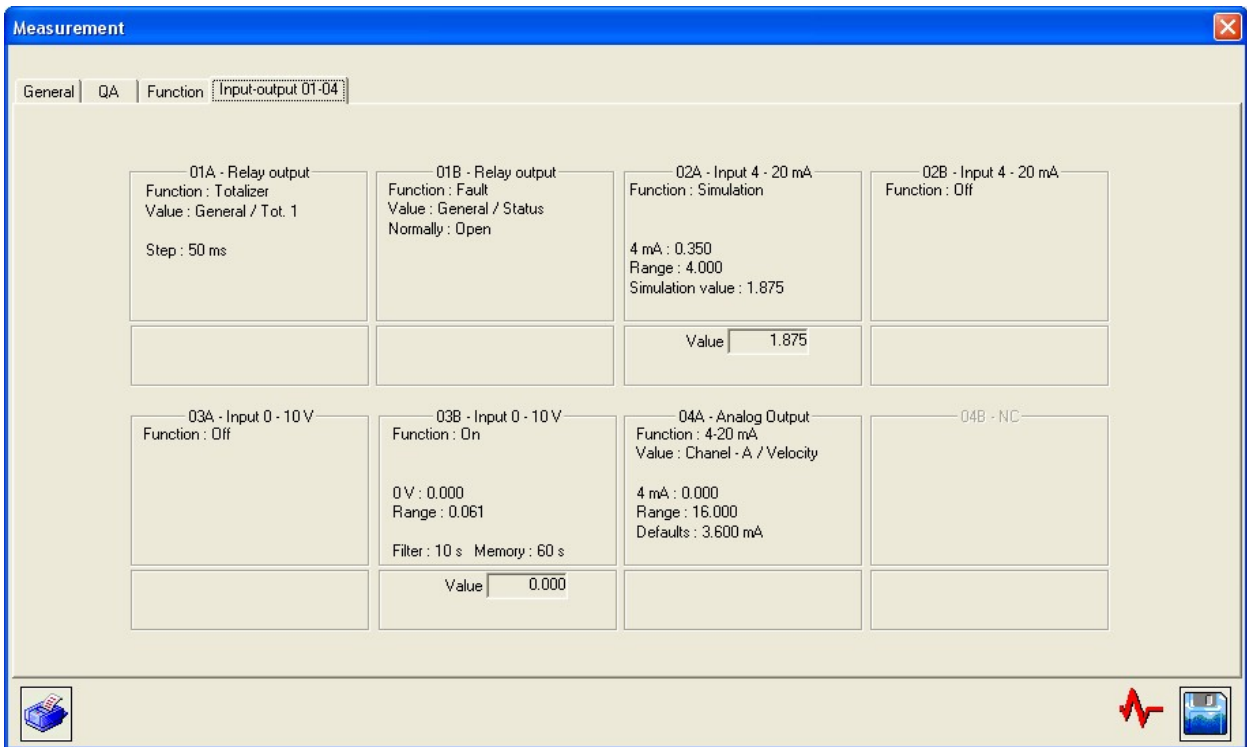

7.1.8 Settings window

1) List of available tabs

This is a complete list showing all the tabs available in Advanced configuration mode. Simple or normal configuration reduces the number of tabs you can access.

The configuration window, opened using the Dialogue/Settings command, contains the following tabs:

- In the "General" drop-down menu
 - "General" tab: selection of the flow meter display language (and name of the flow meter defined during the installation).
 - "Logger" tab: description of the operation of the logger.
 - "Totalizer" tab: definition of the operation of the totalizers.
 - "Function" tab: definition of the engine input constants accessible to the user (when a function is located in the engine).
 - "Advanced" tab: definition of the Advanced operating mode.
 - "Inputs/outputs" tab: definition of the configuration of the inputs and outputs.

- In the "Control" drop-down menu
 - "Control" tab: flow unit, time constants, flow graph settings, display options, etc.
 - "Chord" tab: definition of the probes, positions of the chords, etc.
 - "Advanced chord" tab: definition of specific codes used to fine-tune the behaviour of the flow meter (contact Ultraflux before modifying these settings).
 - "Linearisation" tab: flow rate linearisation coefficient.



Once the settings are completed, upload the configuration to the flow meter by clicking this button.

Comment: On opening the settings window, the configuration loaded in the PC is the current configuration of the flow meter.

2) "General" tab (in the "General" drop-down menu)

The settings window is used to configure the flow meter from the PC. As with the keypad, you can choose the level of complexity using the command: General/Application Selection/Level = Simple, Normal or Advanced.

The screenshot below shows an example of an Advanced mode configuration. All settings displayed below have been described previously in this document.



The software allows the date and time of the Uf 841 to be synchronized with those of the host PC: select the option "Synchronise with PC time" before saving the settings on the flow meter.

It is important to correctly set the date and time in order to time stamp the records (country, summer/winter time).

3) "Logger" tab (in the "General" drop-down menu)

The screenshot below shows an example of settings in Advanced mode. All the settings displayed below have been described previously in this document (see section 5.4.5).

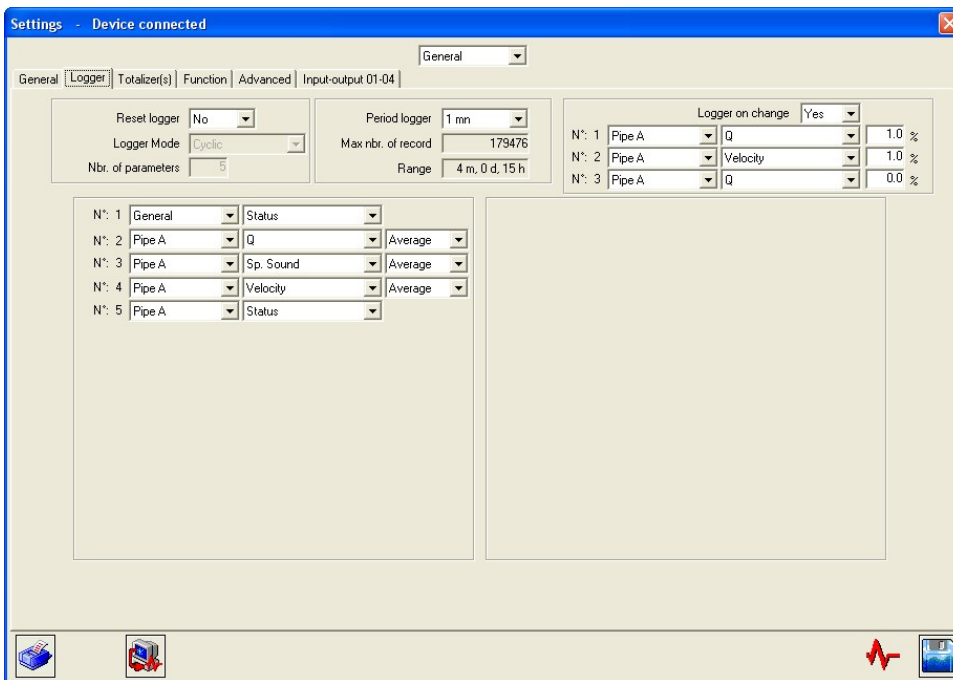

4) "Totalizers" tab (in the "General" drop-down menu)

The screenshot below shows an example of settings in Advanced mode. All the settings displayed below have been described previously in this document (see section 5.4.3).

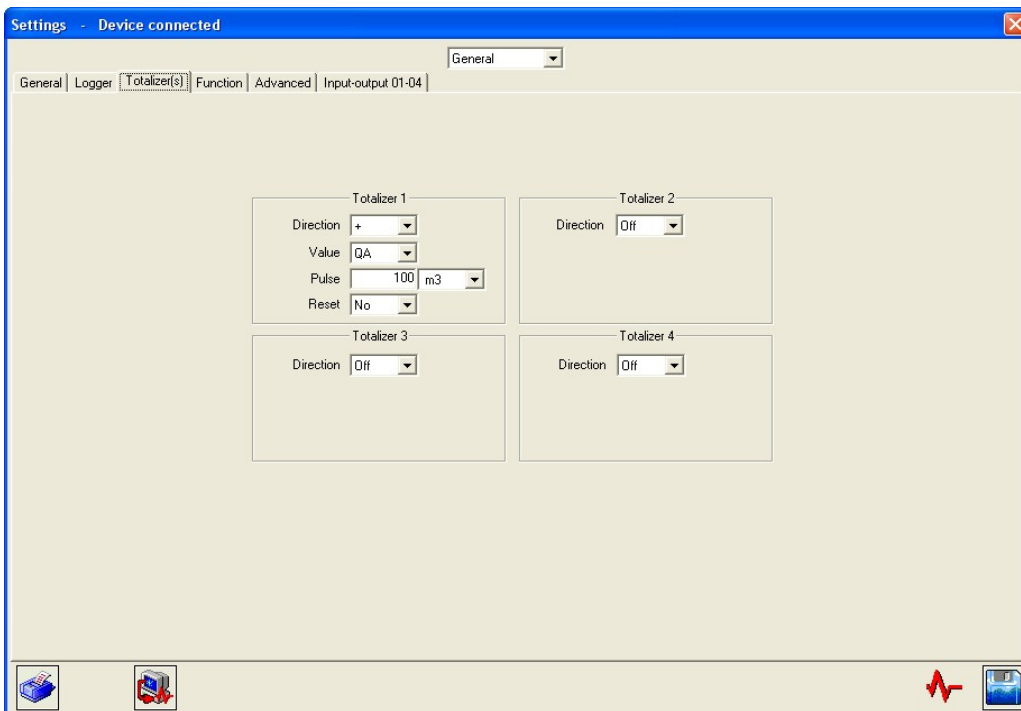

5) "Inputs/Outputs" tab (in the "General" drop-down menu)

The screenshot below shows an example of settings in Advanced mode. All the settings displayed below have been described previously in this document (see section 5.4.4).

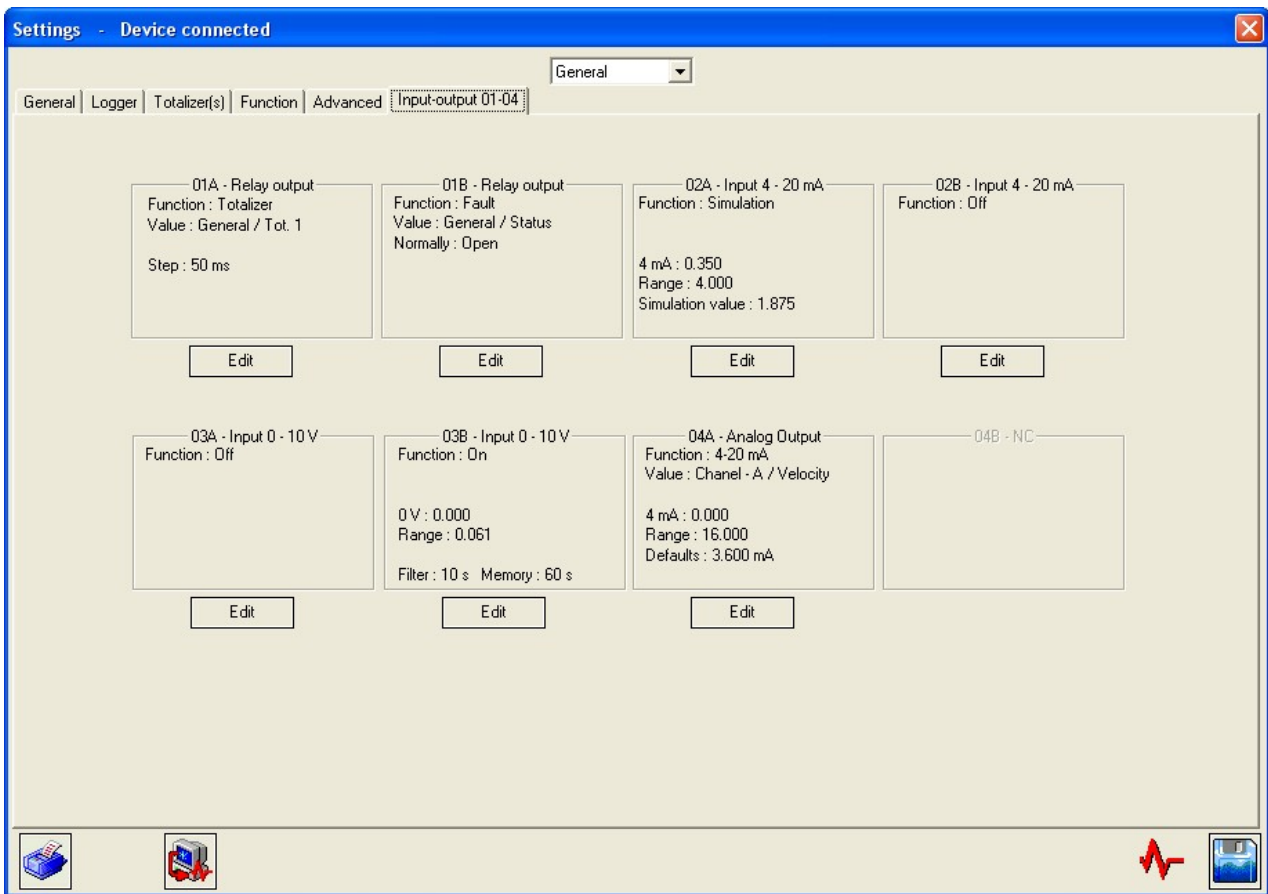

You can choose whether or not to activate the Totalizer, Logger and Input/output functions resources.

6) "Pipe" tab (in the "Pipe" drop-down menu)

The screenshot below shows an example of settings in Advanced mode. All the settings displayed below have been described previously in this document (see section 5.4.2).

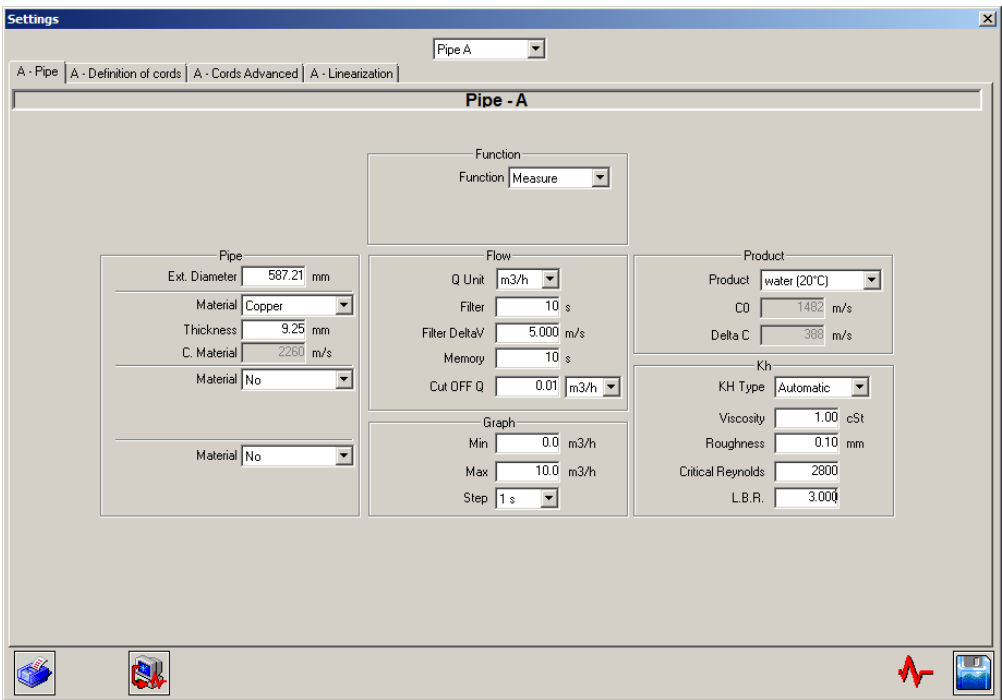

7) "Definition of chords" tab (in the "Pipe" drop-down menu)

The screenshot below shows an example of settings in Advanced mode. All the settings displayed below have been described previously in this document (see section 5.4.2).

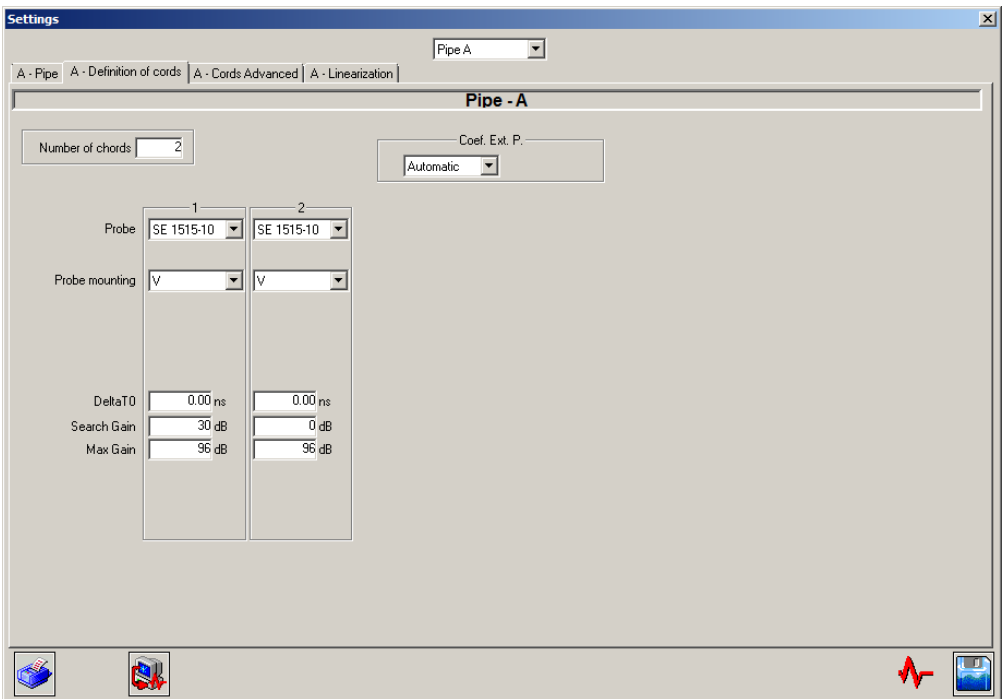

Note: It is possible to enter in the flow rate calculation a chord external to the converter (for example, a Doppler velocity measurement). The settings to be defined for this chord are the same as those for the internal chords, but the following must also be defined:

- the internal chord associated with the external chord: when the internal chord is faulty, the external chord takes over.
- the input module which will serve as a velocity measurement: a 4-20 mA module may be used to recover a Doppler velocity.

The main advantage of this virtual chord lies in being able to measure the flow using several measurement methods.

8) "Linearization" tab (in the "Pipe" drop-down menu)

The screenshot below shows an example of settings in Advanced mode. All the settings displayed below have been described previously in this document (see section 5.6.2).

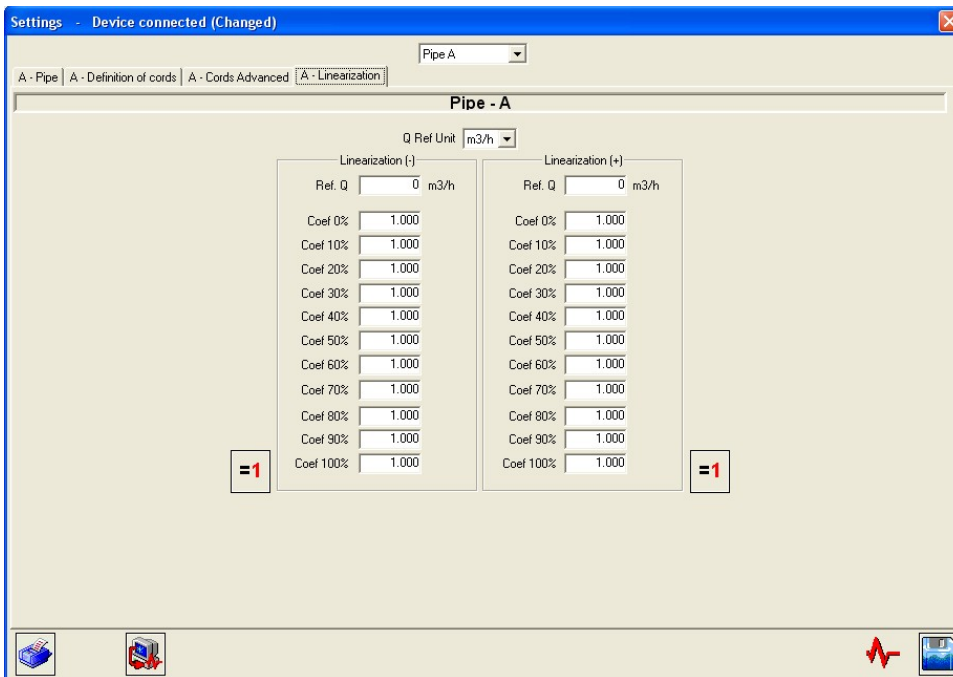

7.2 Archiving, processing and printing of saved files

You can save the settings for the flow meter and the associated measurement results.

These are complete records of the measurements and conditions observed, which are a useful addition to those of the data logger. The files are named with an extension [*].mes].

These records on the screen are presented in the same way as the Measurement dialog (see section 5.7), with a few additional icons at the bottom of the screen.

Use the following buttons to browse or select the records:



Use the following button to print the records:



If you have saved a sequence (Configuration/General/Save file/Period and Time) command), you will be able to process this data with the software used for data handling (Excel by default, if this is installed on your computer). A macro for Excel is provided.

Data processing is called by clicking the following button:



In the windows opened, confirm the name of the file to be processed, and accept the macro. You should first specify the security level of this macro.

The results from the measurement pages are automatically arranged in the columns and rows of Excel, and the flow and velocity curves are produced. You can then freely modify this data.

7.3 Settings files

The Uf 841 has 11 spaces in its free memory for the storage of configurations (see part 5.4.1): you can therefore recall or save your selections.

Important: only the first 5 locations are accessible from the PC software, the other 6 may only be accessed via the converter.

Appendix I: Characteristic echo signals

The most common echo signals

The display of the echo signal is not essential, but does facilitate the implementation of the measuring point. It also allows the origin of a problem to be detected.

The positioning and orientation of the probes are correct when the amplitude of the echo is at its maximum and the echo is rising rapidly, without too much distortion (deformations).

The following figures show the most commonly observed echo signals:

- Ideal signal: quick rise well above the detection threshold.

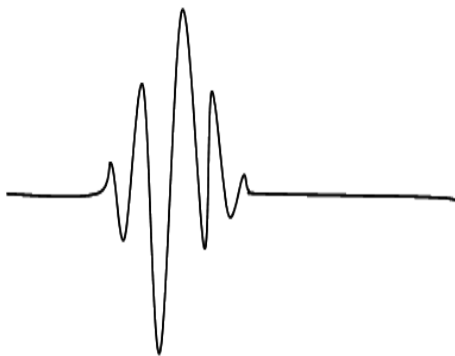

Comment: The signals observed are often longer than the one shown above. This is completely normal, the important criterion being the velocity of the signal rise above the threshold.

- Slowly rising signal:



- Signal distorted by an incorrect positioning of the probes:



- Presence of noise (acoustic interference)

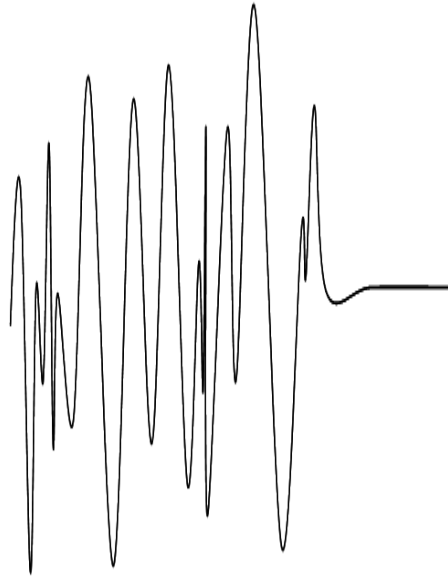

Comment: For the last three cases, a weak signal (gain greater than 50 dB) may mean that the probes require realignment or maintenance (pollution on the surface of the probe).

- Presence of electromagnetic interference



Comment: in this case, move the cables (in particular the probe cables) away from the power cables. Check the ground connections and the shielding.

Appendix II: Speed of sound in water

Sound propagation velocity in water

t (°C)	C (m/s)	t (°C)	C (m/s)
0	1422.8.	30	1506.4.
5	1426.5.	35	1520.1.
10	1447.6.	40	1529.2.
15	1466.3.	45	1536.7.
20	1482.7.	50	1542.9.
25	1497	—	—

Approximate value: $C = 1557 - 0.0245 \cdot (74 - t)^2$

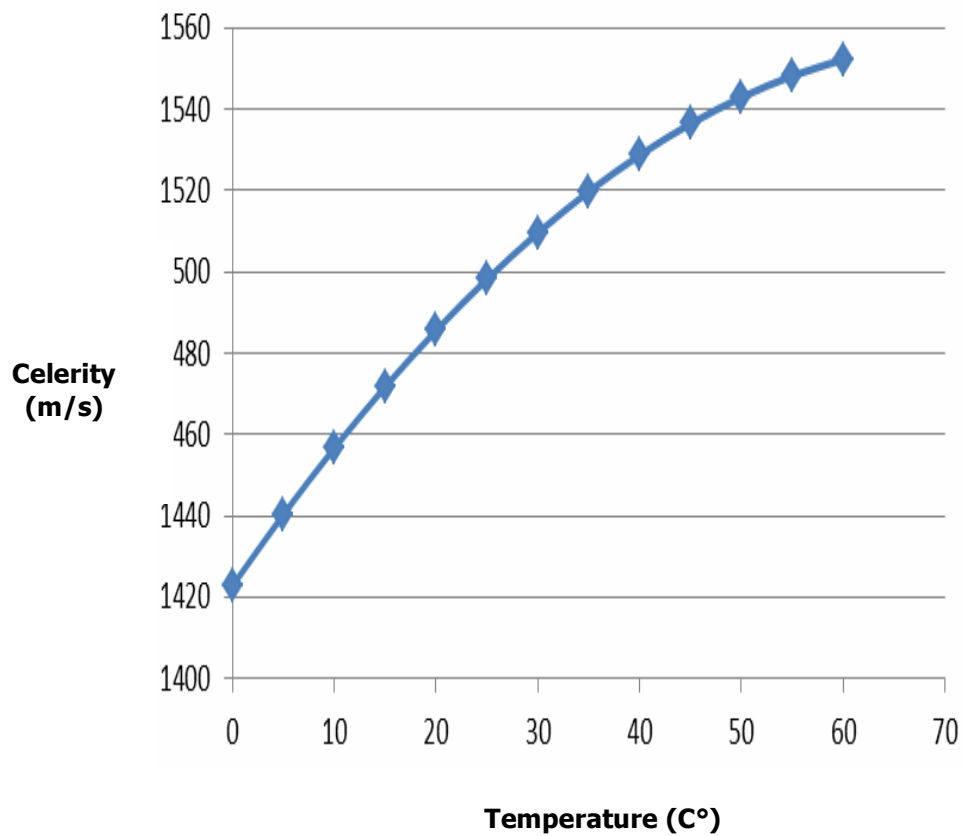

Appendix III Troubleshooting

III.1 Diagnostic indications

III.2 Description of fault bits

III.3 Fault grid

III.1 Diagnostic indications

Certain factors may lead to a degradation of the measurement. The following diagnostic indications will help you to resolve any problems which may occur.

- **The message "Velocity faults" is permanently displayed**

Possible causes:

- Probes different to those indicated in the settings. Incorrect programming of the Daxe and L settings.
- Incorrect connection of the probes. A probe may have been disconnected.
- Presence of a solid body between the probes.
- Chords out of the water.
- Probes incorrectly positioned with regard to each other.
- Probes excessively clogged.
- Fluid too absorbent, too much slurry, excessively aerated. Contact us and we will work with you to find the best solution.
- Probes defective or Uf 841 malfunctioning. Contact us if your checks result in this conclusion.

- **The message "Flow faults" appears intermittently**

The intermittent message "Flow faults" may be due to a weak echo, resulting in a high gain.

The possible causes are, to a lesser extent, identical to those of the "Velocity faults" message (see above), and in particular:

- Probes misaligned,
- Probes clogged,
- Fluid absorbent, or slurry, or aerated.

Comment: A simple way of masking intermittent measurement faults and increasing the memory storage time (see section 5.5.1).

- **The measurement differs from the predicted flow**

Actions to take

- Check that the probes are far enough away from hydraulic disturbances.
- Check the precise dimensions of the section of the pipe or the channel at the location of the measurement and the position of the probes.
- Have faith in your Uf 841.

- **The message "relay overflow" appears permanently or intermittently in the case of a relay output configured in totalizer mode**

Cause:

- Too many pulses output within the allocated time.

Actions to take

- Adapt the pulse weight and/or the width based on the flow of your application (see the "Totalizer" section 5.4.4 - point 5).

- **The message "open loop" appears permanently when setting a current output**

Cause:

- Break in the loop.

- **The message "outside limits" appears permanently or intermittently when setting an analogue input**

Cause:

- Current or voltage outside the range of use.

III.2 Description of fault bits

In general, a bit set to 1 means that there is a fault present and 0 means there is no fault. The numbering of the bits **starts at Zero!**

Two bits have the same meaning on each fault field:

BIT No.	FUNCTION NAME	DESCRIPTION
30	Fault	The measurement is faulty.
31	Not valid	Measurement is not possible, but the situation is not abnormal (1).

(1) For example, all probes are out of flow.

General fault

BIT No.	FUNCTION NAME	DESCRIPTION
4	Logger	At least one reading in the logger is not consistent.
18	Function engine	A problem has occurred on one of the outputs of the function engine. This fault is used to identify a calorimetry problem for example.
19	Ultrasound configuration	The ultrasonic board has a configuration problem.
20	Alarm C	A peripheral system has a fault.
21	Alarm B	Maintenance is required on the flow meter.
22	Alarm A	The flow meter has a general fault.
23	Access code	The maximum number of unlocking attempts has been reached. Please wait before trying again.
24	Configuration access	The configuration has been changed or the device is in echo display mode.
25	Power supply	The power supply has been cut off and restored.
26	Inputs/Outputs	Fault on an input/output module.
27	Internal clock	The clock time must be set correctly.
28	Qb	Fault on the Qb pipe.
29	Qa	Fault on the Qa pipe.
30	QT	Fault on the total flow.
31	QT not valid	Total flow invalid.

Pipe fault

BIT No.	FUNCTION NAME	DESCRIPTION
0	Velocity1	Chord 1 velocity faulty.
1	Velocity2	Chord 2 velocity faulty.
2	Velocity3	Chord 3 velocity faulty.
3	Velocity4	Chord 4 velocity faulty.
4	Velocity5	Chord 5 velocity faulty.
5	Velocity6	Chord 6 velocity faulty.
6	Velocity7	Chord 7 velocity faulty.
7	Velocity8	Chord 8 velocity faulty.
16	General velocity	All velocities are faulty.
17	General level	All levels are faulty.
18	Height velocity	The height velocity law or the automatic regression is activated.
30	Fault	Fault on a velocity.
31	Not valid	Velocity not valid.

Input/output modules fault

BIT No.	FUNCTION NAME	DESCRIPTION
0	On relay A output metering	Relay A cannot output the number of pulses required based on the programmed period.
1	Relay A output outside range	Relay A cannot output the required frequency based on the programmed range.
2	On relay B output metering	Relay B cannot output the number of pulses required based on the programmed period.
3	Relay B output outside range	Relay B cannot output the required frequency based on the programmed range.
4	Current A output loop open	Current loop open.
5	Current A output value outside range	The value of current A is outside the authorized range.
8	Value outside range input PT100/1000	The temperature measurement of PT100 A is outside the authorized range.
12	Current A input value outside range	The measurement of current A is outside the authorized range.
14	Current B input value outside range	The measurement of current B is outside the authorized range.
16	Voltage A input value outside range	The measurement of voltage A is outside the authorized range.
18	Voltage B input value outside range	The measurement of voltage B is outside the authorized range.

Chord fault

BIT No.	FUNCTION NAME	DESCRIPTION
22	Chord immersion	Chord submerged.
26	Overspeed/underspeed	Chord overspeed/underspeed.
29	Flow calculation	Chord taken into account in the flow calculation.
30	Fault	Fault on a chord.
31	Not valid	Chord not valid.

Function fault

BIT No.	FUNCTION NAME	DESCRIPTION
30	Fault	Function output fault.

III.3 Fault grid

There are three types of alarm:

- Alarm A: General fault,
- Alarm B: Maintenance requirement / Degraded mode,
- Alarm C: Alarm on peripheral system.

Using the PC software, you can find the detail of each of these alarms with the key word displayed in the fault window (see the chapter dedicated to the PC software).

The explanation of these key words is given below:

Alarm A:

KEY WORD	EXPLANATION
firmware	There is a recognition problem for the internal software of the flow meter. Contact Ultraflux.
EEprom	The non-volatile memory is faulty, measurement is impossible. Contact Ultraflux.
Function	The function engine has an execution bug. Check the inputs to the function engine. If the problem persists, contact Ultraflux.
Com .ER	There is a programming problem with the two DSP processors. Turn the flow meter off, and then back on. If the problem persists, contact Ultraflux.
Bad software	The internal software of the flow meter is not compatible with the type of flow meter programmed (Full Pipe, Open Channel, ISD, PSD, etc.). Contact Ultraflux.
Q	Fault on the flow.

Alarm B:

KEY WORD	EXPLANATION
velocity	Fault on one of the eight velocities.

Alarm C:

KEY WORD	EXPLANATION
Dataflash	The non-volatile memory is faulty; measurement is possible but not archiving by the logger. Contact Ultraflux.
logger	The logger data cannot be used or is corrupt. Contact Ultraflux.
h/w I/O	One of the inputs/outputs is no longer responding. Contact Ultraflux.
i/o	One of the inputs/outputs is incorrectly configured. Contact Ultraflux.
clock	The clock time must be set correctly.

Appendix IV: Link protocol of the Uf 841

IV.1 Serial link characteristics

IV.2 Reading of N words (with $N \leq 125$)

IV.3 Modbus/Jbus table

IV.4 CRC16 calculation algorithm

IV.2 Reading of N words (with $N \leq 125$)

The function code for reading N words is 3.

Request

Data	Slave no.	3	address 1st word	number of words	CRC16
Size	1 byte	1 byte	2 bytes	2 bytes	2 bytes

Response

Data	Slave no.	3	number of bytes read	value 1st word	value last word	CRC16
Size	1 byte	1 byte	1 byte	2 bytes	2 bytes	2 bytes

IV.3 Modbus / Jbus table

(1): full pipe only
(2): open channel only

For the other pipes (C & D), there is simply an offset address of 200 hexadecimal or 512 decimal between each pipe

PARAMETER NAME	Type	Pipe A		Pipe B	
		JBUS Hex address	JBUS Dec address	JBUS Hex address	JBUS Dec address
Logger		0200	512	0400	1024
No. Variables Per Line	USHORT	0200	512	0400	1024
No. Completed Lines	ULONG	0201	513	0401	1025
Max. Line No.	ULONG	0203	515	0403	1027
Period (seconds)	ULONG	0205	517	0405	1029
		0207	519	0407	1031
Totalizers		0207	519	0407	1031
Totalizer1 value	ULONG	0207	519	0407	1031
Totalizer1 Weight	USHORT	0209	521	0409	1033
Totalizer1 Unit	USHORT	020A	522	040A	1034
Totalizer2 value	ULONG	020B	523	040B	1035
Totalizer2 Weight	USHORT	020D	525	040D	1037
Totalizer2 Unit	USHORT	020E	526	040E	1038
Totalizer3 value	ULONG	020F	527	040F	1039
Totalizer3 Weight	USHORT	0211	529	0411	1041
Totalizer3 Unit	USHORT	0212	530	0412	1042
Totalizer4 value	ULONG	0213	531	0413	1043
Totalizer4 Weight	USHORT	0215	533	0415	1045
Totalizer4 Unit	USHORT	0216	534	0416	1046
		0217	535	0417	1047
		0217	535	0417	1047
Year Clock	USHORT	0217	535	0417	1047
Clock Month	USHORT	0218	536	0418	1048
Clock Days	USHORT	0219	537	0419	1049
Clock Hour	USHORT	021A	538	041A	1050
Clock Minutes	USHORT	021B	539	041B	1051
Clock Seconds	USHORT	021C	540	041C	1052
QT Q	FLOAT	021D	541	041D	1053
QT unit	USHORT	021F	543	041F	1055
QT Fault	ULONG	0220	544	0420	1056
		0222	546	0422	1058
Pipe / Channel		0222	546	0422	1058
Q	FLOAT	0222	546	0422	1058
Flow unit index	USHORT	0224	548	0424	1060
Average V	FLOAT	0225	549	0425	1061
Average C	FLOAT	0227	551	0427	1063
KH (1)	FLOAT	0229	553	0429	1065
Reynolds (1)	FLOAT	022B	555	042B	1067
Surface	FLOAT	022D	557	042D	1069
Level (2)	FLOAT	022F	559	042F	1071
Height / Channel Description Point (2)	FLOAT	0231	561	0431	1073
Water Height (2)	FLOAT	0233	563	0433	1075
Water Height Max. Delta (2)	FLOAT	0235	565	0435	1077
Fault	ULONG	0237	567	0437	1079
		0239	569	0439	1081

		Pipe A		Pipe B	
PARAMETER NAME	Type	JBUS Hex address	JBUS Dec address	JBUS Hex address	JBUS Dec address
chord 01		0239	569	0439	1081
Average V	FLOAT	0239	569	0439	1081
T	FLOAT	023B	571	043B	1083
DeltaT	FLOAT	023D	573	043D	1085
C	FLOAT	023F	575	043F	1087
Gain	FLOAT	0241	577	0441	1089
IQ	FLOAT	0243	579	0443	1091
Fault	ULONG	0245	581	0445	1093
Probe Reference	USHORT	0247	583	0447	1095
Distance Between Probes	USHORT	0248	584	0448	1096
		0249	585	0449	1097
chord 02		0249	585	0449	1097
Average V	FLOAT	0249	585	0449	1097
T	FLOAT	024B	587	044B	1099
DeltaT	FLOAT	024D	589	044D	1101
C	FLOAT	024F	591	044F	1103
Gain	FLOAT	0251	593	0451	1105
IQ	FLOAT	0253	595	0453	1107
Fault	ULONG	0255	597	0455	1109
Probe Reference	USHORT	0257	599	0457	1111
Distance Between Probes	USHORT	0258	600	0458	1112
		0259	601	0459	1113
chord 03		0259	601	0459	1113
Average V	FLOAT	0259	601	0459	1113
T	FLOAT	025B	603	045B	1115
DeltaT	FLOAT	025D	605	045D	1117
C	FLOAT	025F	607	045F	1119
Gain	FLOAT	0261	609	0461	1121
IQ	FLOAT	0263	611	0463	1123
Fault	ULONG	0265	613	0465	1125
Probe Reference	USHORT	0267	615	0467	1127
Distance Between Probes	USHORT	0268	616	0468	1128
		0269	617	0469	1129
chord 04		0269	617	0469	1129
Average V	FLOAT	0269	617	0469	1129
T	FLOAT	026B	619	046B	1131
DeltaT	FLOAT	026D	621	046D	1133
C	FLOAT	026F	623	046F	1135
Gain	FLOAT	0271	625	0471	1137
IQ	FLOAT	0273	627	0473	1139
Fault	ULONG	0275	629	0475	1141
Probe Reference	USHORT	0277	631	0477	1143
Distance Between Probes	USHORT	0278	632	0478	1144
		0279	633	0479	1145

		Pipe A		Pipe B	
PARAMETER NAME	Type	JBUS Hex address	JBUS Dec address	JBUS Hex address	JBUS Dec address
Inputs/Outputs		02C9	713	04C9	1225
IO 01A		02C9	713	04C9	1225
Value	FLOAT	02C9	713	04C9	1225
Fault	ULONG	02CB	715	04CB	1227
		02CD	717	04CD	1229
IO 01B		02CD	717	04CD	1229
Value	FLOAT	02CD	717	04CD	1229
Fault	ULONG	02CF	719	04CF	1231
		02D1	721	04D1	1233
IO 02A		02D1	721	04D1	1233
Value	FLOAT	02D1	721	04D1	1233
Fault	ULONG	02D3	723	04D3	1235
		02D5	725	04D5	1237
IO 02B		02D5	725	04D5	1237
Value	FLOAT	02D5	725	04D5	1237
Fault	ULONG	02D7	727	04D7	1239
		02D9	729	04D9	1241
IO 03A		02D9	729	04D9	1241
Value	FLOAT	02D9	729	04D9	1241
Fault	ULONG	02DB	731	04DB	1243
		02DD	733	04DD	1245
IO 03B		02DD	733	04DD	1245
Value	FLOAT	02DD	733	04DD	1245
Fault	ULONG	02DF	735	04DF	1247
		02E1	737	04E1	1249
IO 04A		02E1	737	04E1	1249
Value	FLOAT	02E1	737	04E1	1249
Fault	ULONG	02E3	739	04E3	1251
		02E5	741	04E5	1253
IO 04B		02E5	741	04E5	1253
Value	FLOAT	02E5	741	04E5	1253
Fault	ULONG	02E7	743	04E7	1255
		02E9	745	04E9	1257

		Pipe A		Pipe B	
PARAMETER NAME	Type	JBUS Hex address	JBUS Dec address	JBUS Hex address	JBUS Dec address
Function output Start		0319	793	0519	1305
Function output 01		0319	793	0519	1305
Value	FLOAT	0319	793	0519	1305
Fault	ULONG	031B	795	051B	1307
		031D	797	051D	1309
Function output 02		031D	797	051D	1309
Value	FLOAT	031D	797	051D	1309
Fault	ULONG	031F	799	051F	1311
		0321	801	0521	1313
Function output 03		0321	801	0521	1313
Value	FLOAT	0321	801	0521	1313
Fault	ULONG	0323	803	0523	1315
		0325	805	0525	1317
Function output 04		0325	805	0525	1317
Value	FLOAT	0325	805	0525	1317
Fault	ULONG	0327	807	0527	1319
		0329	809	0529	1321
Function output 05		0329	809	0529	1321
Value	FLOAT	0329	809	0529	1321
Fault	ULONG	032B	811	052B	1323
		032D	813	052D	1325
Function output 06		032D	813	052D	1325
Value	FLOAT	032D	813	052D	1325
Fault	ULONG	032F	815	052F	1327
		0331	817	0531	1329
Function output 07		0331	817	0531	1329
Value	FLOAT	0331	817	0531	1329
Fault	ULONG	0333	819	0533	1331
		0335	821	0535	1333
Function output 08		0335	821	0535	1333
Value	FLOAT	0335	821	0535	1333
Fault	ULONG	0337	823	0537	1335
		0339	825	0539	1337
Function output 09		0339	825	0539	1337
Value	FLOAT	0339	825	0539	1337
Fault	ULONG	033B	827	053B	1339
		033D	829	053D	1341
Function output 10		033D	829	053D	1341
Value	FLOAT	033D	829	053D	1341
Fault	ULONG	033F	831	053F	1343

IV.4 CRC16 calculation algorithm

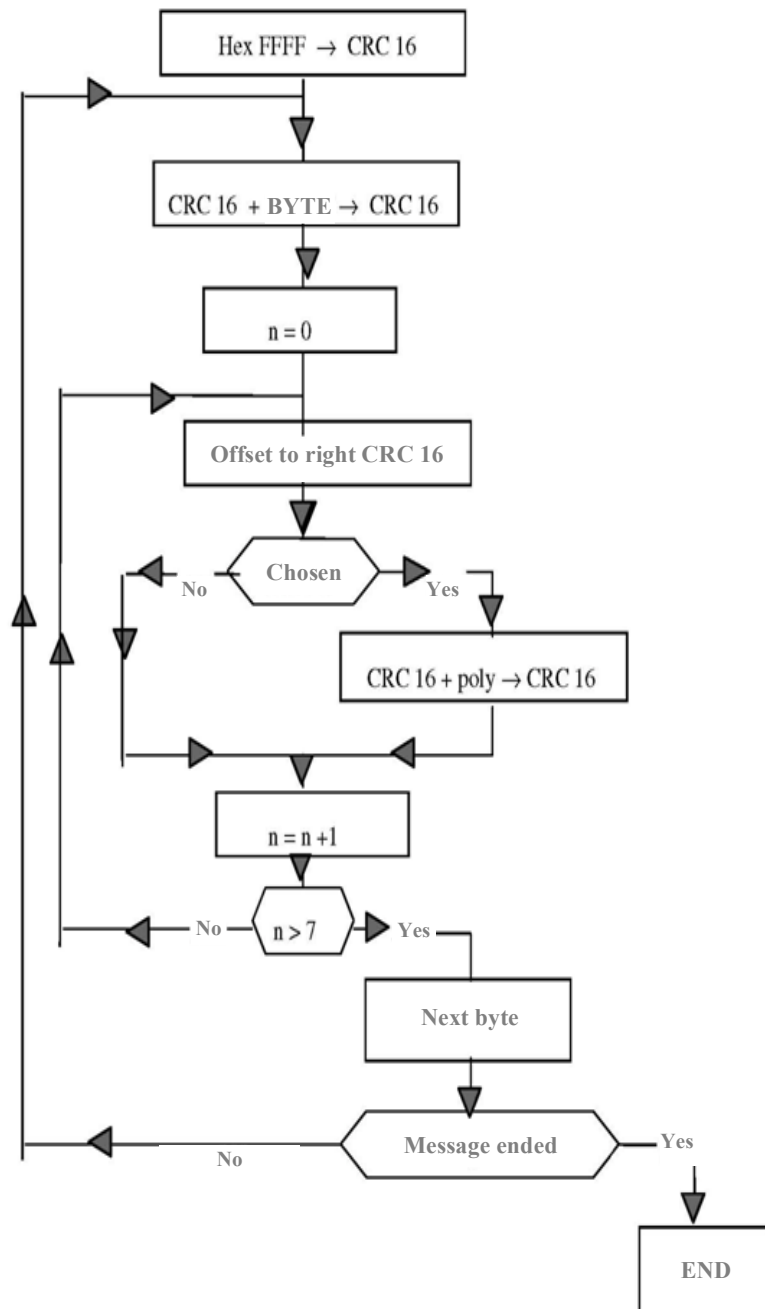

\oplus = exclusive OR

n = number of bits

poly = calculation polynomial of CRC16 = 1010 0000 0000 0001 (generator polynomial = $2 X^2 X^{15} X^{16}$)

the first byte sent is the one with the least significant bits

Detailed table of contents

CHAPTER 1: OVERVIEW	4
1.1 Overall view of the converter	5
1.1.1 Unit closed	5
1.1.2 Unit open	6
1.2 Functions	7
1.3 Dimensions and weight	7
1.4 Operating environment	7
1.5 Protection against dust and immersion	7
1.6 Power supply	8
1.7 Communication	8
1.8 Inputs/Outputs	9
1.9 Ultrasound chords	9
1.10 Navigation keys	9
1.11 Operating lights	10
1.12 Screen	10
1.13 Performance of the flow meter	11
1.14 Cleaning the flow meter	11
1.15 Recycling the flow meter	11
1.16 CE marking	11
CHAPTER 2: SAFETY INSTRUCTIONS	12
2.1 Using the flow meter	13
2.2 Equipment connected to the flow meter	13
2.3 Symbols used on the flow meter	14
2.4 Maintenance work on the flow meter	15
2.5 Contact address	16
CHAPTER 3: INSTALLATION AND WIRING	17
3.1 General	18
3.2 Attachment	18
3.3 Opening the casing	20
3.4 Wiring instructions	20
3.5 Connection to the protective ground (to be carried out first)	21
3.6 Wiring the Terminals	21
3.6.1 Power supply	21
3.6.2 Ultrasonic chords	22
3.6.3 Input/output terminals	23
1) Wiring of the current output modules	23
2) Wiring of the current input modules	23

3) Wiring of the voltage input modules	23
4) Wiring of the relay modules	23
5) Wiring of the temperature modules	24
3.6.4 Communication terminal board	24

CHAPTER 4: INSTALLING A MEASURING POINT 25

4.1 Composition of a measuring point	26
4.2 Choosing the measurement location	26
4.2.1 Straight lengths to be used	26
1) Monochord measurement	26
2) Multichord measurement	28
4.3 Choosing the probe location	30
4.4 Installing probes and connectors	32
4.4.1. Permanent external (clamp-on) probes	32
1) Preparing the pipe	32
2) Installing the elastomer strip	32
3) Installing the probe	32
4.4.2. Temporary external (clamp-on) probes	32
1) Preparing the pipe	32
2) Selecting and installing the coupling medium	32
3) Installing the probe	33
4.4.3. Inserted probes	33
1) Flanged probes	33
2) Screw probes	34
3) Probes with air lock	34

CHAPTER 5: USING AND CONFIGURING THE Uf 841 35

5.1 Using the Uf 841	36
5.1.1 Operating mode	36
5.1.2 Keypad	37
5.1.3 LEDs	38
5.2 Main configuration elements	39
5.2.1 Number of channels	39
5.2.2 Description of the pipe	39
5.3 Configuring the Uf 841	39
5.3.1 Flow meter menu ("Settings" mode)	40
5.4 SIMPLE configuration	41
5.4.1 "Configuration" Menu	41
1) "Config. Files" Window	41
2) Reinitialisation	41
3) Confirmation (of reinitialisation)	41
4) Configuration	42
5) Menus	42
6) Access code	42
7) Language	42
8) Station name	42
9) Back light	43
10) Link	43
11) Timer before return to "Measurement" mode	43
5.4.2 "Pipe/fluid configuration" menu	43
1) Number of chords	43
2) Flow rate unit (Q unit)	43
3) Flow graph	43
4) Chord settings	44
5) Type of fluid	44
6) Definition of the pipe	44
5.4.3 "Totalizer configuration" menu (if enabled)	45
1) Activation and counting direction	45
2) Pulse unit and weight	45
3) Resetting a totalizer (if authorised)	45
5.4.4 "Inputs/Outputs" menu (if enabled)	46

1) Current input and voltage input module	46
2) Temperature input module	47
3) Contact input module	47
4) Current/voltage output module	47
5) Relay output module	48
5.4.5 "Logger settings" menu (if enabled)	50
1) Resetting the logger	50
2) Confirmation of resetting the logger	50
3) Number of parameters for the logger	50
4) Logger mode	50
5) Logger interval	50
6) Logger autonomy	50
7) Logger variables	51
8) Log on variation	51
5.4.6 "Echo display" menu	52
5.5 NORMAL configuration	53
5.5.1 "Pipe/fluid configuration" menu	53
1) Memory	53
2) Filter	54
3) Delta T0 and Auto zero	55
4) C0 and Delta C	55
5) KH	56
6) Deletion rate (Qeff)	56
5.6 ADVANCED configuration	57
5.6.1 "Pipe/fluid configuration" menu	57
1) Delta V filtering	57
2) Material of the pipe wall	57
3) Laminar/turbulent transition	58
4) Seek gain and Gain max	58
5) Weighting coefficients of the chords	59
5.6.2 "Linearisation settings" menu	59
5.6.3 "Advanced settings" menu	60
1) Simulation mode	60
2) Special probes	60
3) US & TRT processing	60
5.6.4 "Firmware update" menu	60
5.7 "Measurement" mode	61
5.7.1 Pages available	61
1) Flow	61
2) Pipe measurements	61
3) Specific information relating to the chords	61
4) Totalizers	62
5) Date and time	62
6) Info logger	62
7) Events	62
8) Distance between probes	63
9) Flow graph	63
5.7.2 Verification of the quality and consistency of the measurement	63
CHAPTER 6: FUNCTION ENGINE	64
6.1 Principle	65
6.2 Application examples: Calorimetry	65
6.2.1 Water temperature calculation	65
6.2.2 Calorimetry	65
6.3 Application examples: Conversion of gas flow rate into standardised flow rate	67
6.3.1 Integration of pressure and temperature	67
6.3.2 Reading the standardised flow rate	67
CHAPTER 7: PC SOFTWARE	68
7.1 Introduction	69
7.1.1 Installing and running the software	69
7.1.2 Connecting the flow meter to the PC	70

7.1.3 Home page	70
7.1.4 Configuration window	71
7.1.5 Icons	71
7.1.6 File menu	72
7.1.7 Measurement window	72
1) List of available tabs	72
2) "General" tab	73
3) "QA" tab (flow rate)	74
4) "Inputs/outputs" tab	75
7.1.8 Settings window	75
1) List of available tabs	75
2) "General" tab (in the "General" drop-down menu)	76
3) "Logger" tab (in the "General" drop-down menu)	77
4) "Totalizers" tab (in the "General" drop-down menu)	77
5) "Inputs/Outputs" tab (in the "General" drop-down menu)	78
6) "Pipe" tab (in the "Pipe" drop-down menu)	79
7) "Definition of chords" tab (in the "Pipe" drop-down menu)	79
8) "Linearization" tab (in the "Pipe" drop-down menu)	80
7.2 Archiving, processing and printing of saved files	81
7.3 Settings files	81
Appendix I: Characteristic echo signals	82
Appendix II: Speed of sound in water	85
Appendix III Troubleshooting	87
III.1 Diagnostic indications	88
III.2 Description of fault bits	90
III.3 Fault grid	93
Appendix IV: Link protocol of the Uf 841	94
IV.1 Serial link characteristics	95
IV.2 Reading of N words (with $N \leq 125$)	96
IV.3 Modbus / Jbus table	97
IV.4 CRC16 calculation algorithm	101